



Pompe centrifughe che abbinano medie prevalenze a portate medio alte; adatte per irrigazioni a pioggia e in generale dove oltre alla silenziosità viene richiesta una lieve oscillazione di pressione al variare della portata.

Centrifugal pumps that combine medium head with medium-high delivery; ideal for sprinkle irrigation and in applications where quiet operations are requested and only slight pressure change as the delivery changes.

Bombas centrífugas que combinan prevalencias medias con caudales medio-altos; apropiadas para riegos por aspersión en general donde además del silencio se solicita una leve oscilación de presión cuando varía el caudal.

Pompes centrifuges qui associent des hauteurs manométriques moyennes à des débits moyens-élevés; adaptées pour l'irrigation par aspersion et, en général, quand, en plus du bruit limité, il faut assurer une légère oscillation de pression en fonction de la variation du débit.

**CARATTERISTICHE COSTRUTTIVE / CONSTRUCTION FEATURES
CARACTERÍSTICAS CONSTRUCTIVAS / CARACTÉRISTIQUES D'EXÉCUTION**

Corpo pompa	ghisa
Pump body	cast iron
Cuerpo bomba	fundición
Corps de pompe	fonte
Supporto motore	ghisa
Motor bracket	cast iron
Soporte motor	fundición
Support moteur	fonte
Girante	ottone (CH 160-310) ghisa (CH 350-550)
Impeller	brass (CH 160-310) cast iron (CH 350-550)
Rodete	latón (CH 160-310) fundición (CH 350-550)
Turbine	laiton (CH 160-310) fonte (CH 350-550)
Tenuta meccanica	ceramica-grafite
Mechanical seal	ceramic-graphite
Sello mecánico	cerámica-grafito
Garniture mécanique	céramique-graphite
Albero motore	acciaio AISI 303
Motor shaft	stainless steel AISI 303
Eje motor	acero AISI 303
Arbre moteur	acier AISI 303
Temperatura del liquido	
Liquid temperature	0 - 90 °C
Temperatura del liquido	
Température du liquide	
Pressione di esercizio	
Operating pressure	max 6 bar
Presión de trabajo	
Pression de fonctionnement	
MOTORE / MOTOR / MOTOR / MOTEUR	
Motore 2 poli a induzione	3~ 220/380V - 60Hz
2 pole induction motor	1~ 220V - 60Hz
Motor de 2 polos a inducción	con termoprotettore with thermal protection
Moteur à induction à 2 pôles	con protección térmica avec protection thermique
Classe di isolamento	
Insulation class	F
Clase de aislamiento	
Classe d'isolation	
Grado di protezione	
Protection degree	IP44
Grado de protección	
Protection	

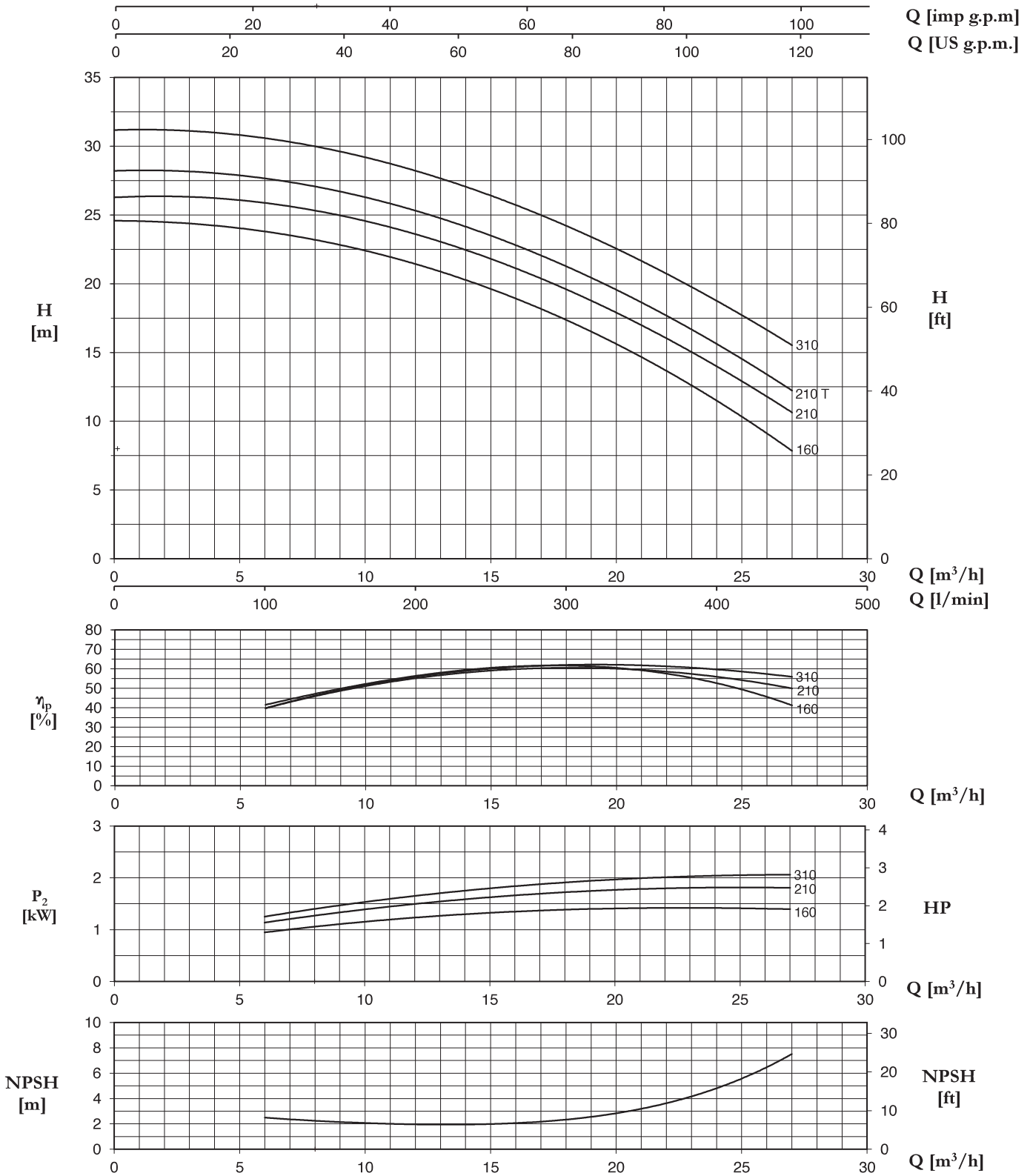

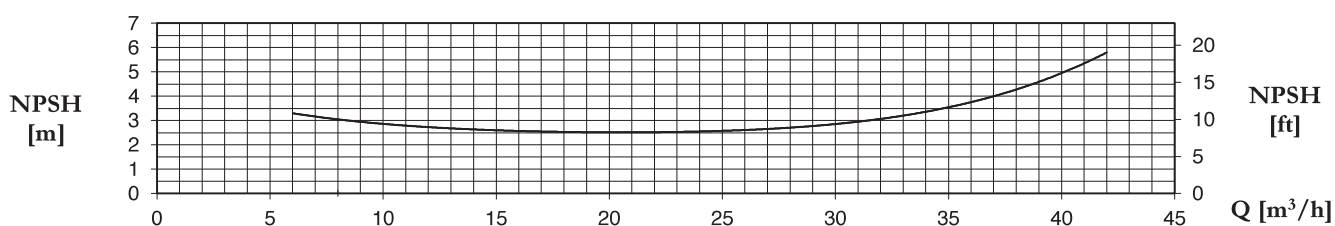
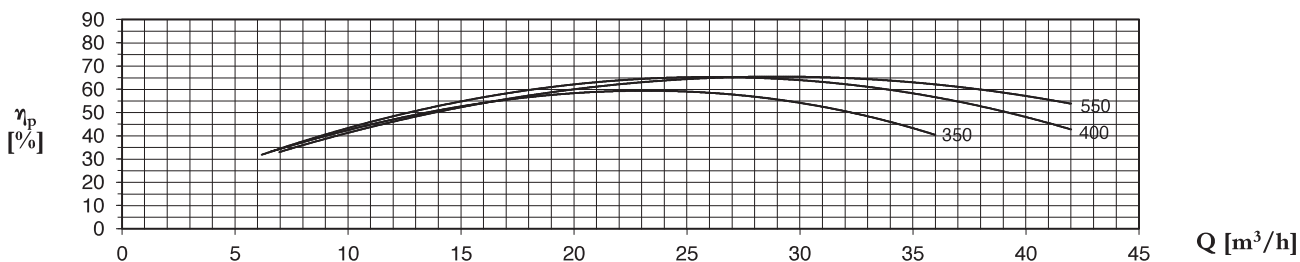
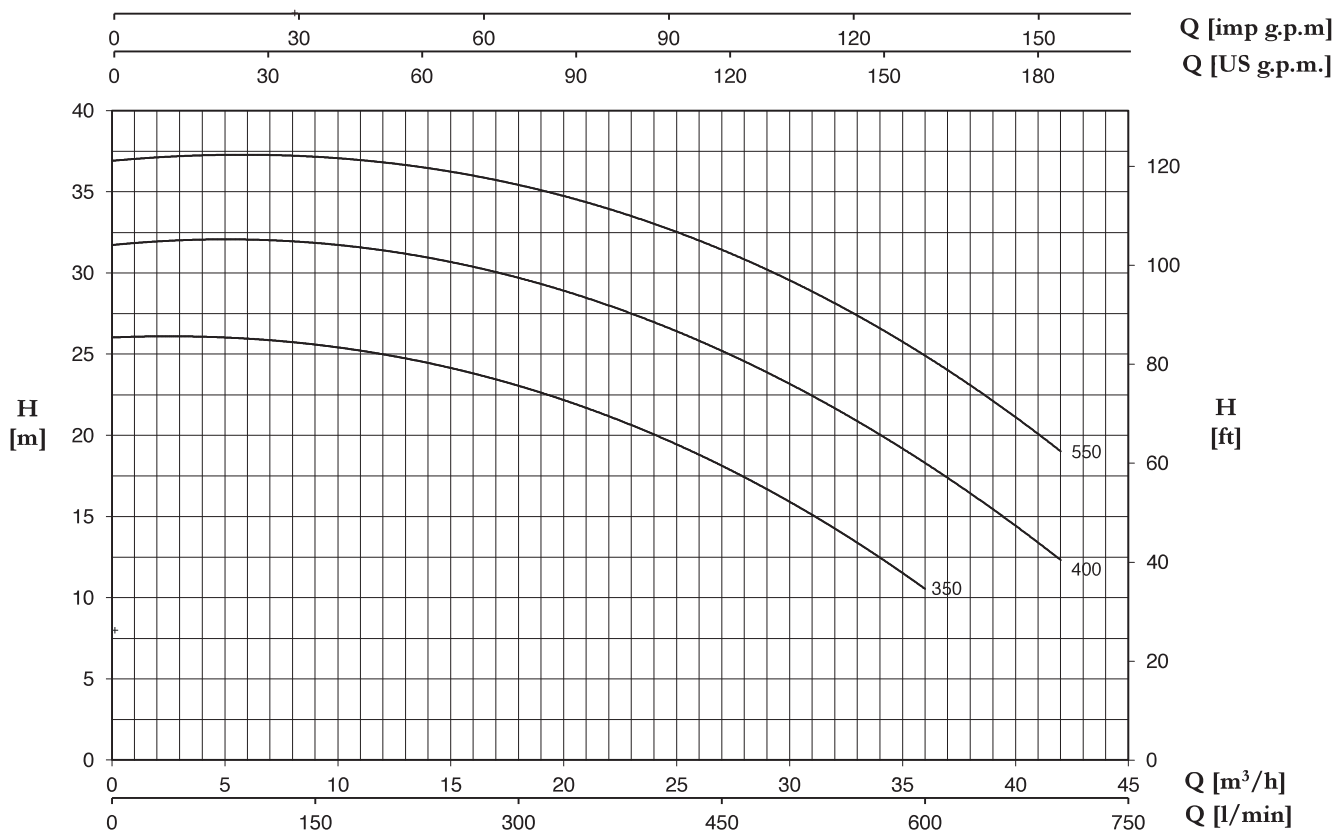

TYPE		P2		P1 (kW)		AMPERE		Q (m³/h - l/min)								
1~	3~					1~	3~	0	6	9	12	15	18	21	24	27
		(HP)	(kW)	1~	3~	1x220 V 60 Hz	3x380 V 60 Hz	H (m)								
CH 160	CHT 160	1,5	1,1	1,8	1,8	8,3	3,4	24,5	23,9	22,9	21,4	19,5	17,3	14,7	11,6	7,8
CH 210	-	2	1,5	2,1	-	10,1	-	26,3	25,9	25,0	23,6	21,7	19,6	17,1	14,1	10,6
-	CHT 210	2	1,5	-	2,2	-	4,7	28,2	27,6	26,7	25,3	23,5	21,3	18,6	15,6	12,2
CH 310	CHT 310	3	2,2	2,8	2,6	12,4	5,0	31,2	30,5	29,6	28,3	26,4	24,3	21,6	18,6	15,6

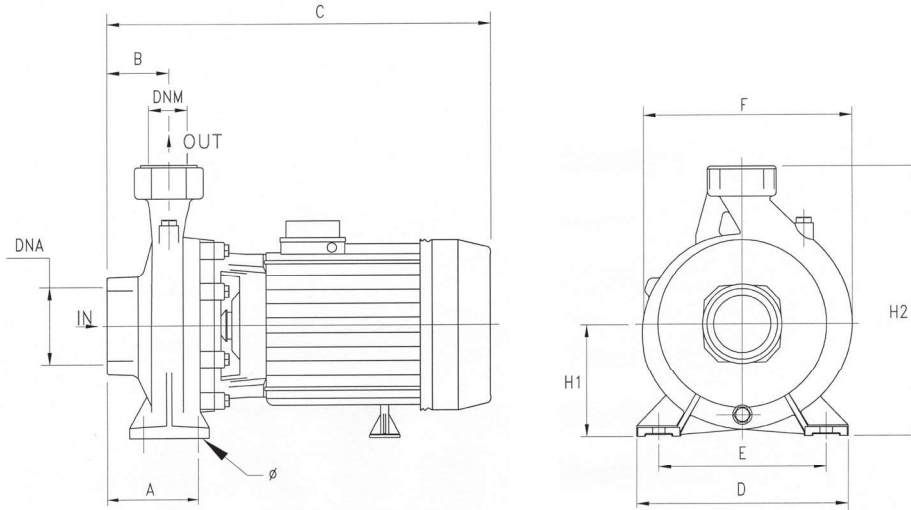

TYPE		P2		P1 (kW)		AMPERE		Q (m³/h - l/min)						
1~	3~	(HP)	(kW)	1~	3~	1~	3~	6	12	18	24	30	36	42
								100	200	300	400	500	600	700
								H (m)						
						1x220 V 60 Hz	3x380 V 60 Hz							
CH 350	CHT 350	3	2,2	2,95	2,84	13,5	5,1	26	25	23	20	16	10,5	-
CH 400	CHT 400	4	3	4,6	4,2	20,5	7,6	31,8	31,6	29,7	27	23	18,4	12,3
-	CHT 550	5,5	4	-	5,1	-	10	37	37	35,5	33	29,4	25	19



TYPE	DIMENSIONS (mm)														
	A	B	C	D	E	F	Ø	H1	H2	DNA	DNM	I	L		M
CH 160	105	48	370	200	160	215	9.5	110	280	2" G	2" G	390	230	300	22
CH 210	105	48	370	200	160	215	9.5	110	280	2" G	2" G	390	230	300	24
CH 310	105	48	410	200	160	215	9.5	110	280	2" G	2" G	430	230	300	32
CHT 310	105	48	370	200	160	215	9.5	110	280	2" G	2" G	390	230	300	26
CH 350	105	70	425	240	190	240	14	126	306	3" G	2" G	460	270	360	34,5
CHT 350	105	70	385	240	190	240	14	126	306	3" G	2" G	400	270	360	28,5
CH 400	105	70	445	240	190	240	14	126	306	3" G	2" G	460	270	360	38,7
CHT 400	105	70	425	240	190	240	14	126	306	3" G	2" G	460	270	360	33,2
CHT 550	105	70	445	240	190	240	14	126	306	3" G	2" G	460	270	360	38,7

TYPE				
	TRUCK		CONTAINER	
	PALLET (cm)	N° pumps	PALLET (cm)	N° pumps
CH 160-310	85X11X140	40	85X110X195	60
CH 350-550	85X110X150	30	85X110X180	30