

CA/CAT EN 733 ~ 2900 r.p.m.
CAX EN 733 ~ 2900 r.p.m.
4CA/4CAT EN 733 ~ 1450 r.p.m.
4CAX EN 733 ~ 1450 r.p.m.



CA/CAT
4CA/4CAT



CAX
4CAX

CARATTERISTICHE COSTRUTTIVE / CONSTRUCTION FEATURES
CARACTERÍSTICAS CONSTRUCTIVAS / CARACTÉRISTIQUES D'EXÉCUTION

Corpo pompa Pump body Cuerpo bomba Corps de pompe	ghisa (CA/CAT) - acciaio inossidabile AISI 316 (CAX) cast iron (CA/CAT) - stainless steel AISI 316 (CAX) fundición (CA/CAT) - acero inoxidable AISI 316 (CAX) fonte (CA/CAT) - acier inox AISI 316 (CAX)
Supporto motore Motor bracket Soporte motor Support moteur	ghisa cast iron fundición fonte
Girante Impeller Rodete Turbine	ghisa, bronzo, acciaio (CA/CAT) - acciaio (CAX) cast iron, bronze, steel (CA/CAT) - steel (CAX) fundición, bronce, acero (CA/CAT) - acero (CAX) fonte, bronze, acier (CA/CAT) - acier (CAX)
Tenuta Seal Sello Garniture	meccanica ceramica-grafite (CA/CAX) o a baderna cotone impregnato grafite (CAT) mechanical ceramic-graphite (CA/CAX) or gland packing graphite impregnated (CAT) mecánico cerámica-grafito (CA/CAX) o a trenza algodón impregnado de grafito (CAT) mécanique céramique-graphite (CA/CAX) ou à baderne coton imprégné graphite (CAT)
Sporgenza albero motore Pump shaft end Bomba eje Pompe arbre	acciaio AISI 316 stainless steel AISI 316 acero AISI 316 acier AISI 316
Temperatura del liquido Liquid temperature Temperatura del liquido Température du liquide	-10 ÷ +90 °C
Pressione di esercizio Operating pressure Presión de trabajo Pression de fonctionnement	max 10 bar max 14 bar (... -315 ~ 2900 r.p.m.)
MOTORE / MOTOR / MOTOR / MOTEUR	
Disponibile con motore classe di efficienza IE3 o standard Available with IE3 efficiency class motor or standard Disponibile con motor clase IE3 o estandar Disponible avec moteur classe IE3 ou standard	

Pompe centrifughe ad asse libero costruite secondo le norme EN 733; trovano vasto utilizzo nell'alimentazione idrica, negli impianti di pressurizzazione e antincendio; come standard vengono fornite di controflangia.

Bare shaft centrifugal pumps constructed to EN 733 standards; widely used in water supplies, pressurisation and fire-fighting systems, standard supply with counter-flange.

Bombas centrífugas de eje libre fabricadas según las normas EN 733; se utilizan en gran parte en la alimentación hídrica, en las instalaciones de presurización y antiincendio; según el estándar se suministran con contrabrida.

Pompes centrifuges à axe libre, fabriquées conformément aux normes EN 733. Elles trouvent une ample utilisation dans l'approvisionnement d'eau, dans les installations de pressurisation et anti-incendie; fournies de série avec contre-bride.

~ 2900 r.p.m. CA/CAT - CAX EN 733
~ 1450 r.p.m. 4CA/4CAT - 4CAX EN 733

VARIANTI COSTRUTTIVE / VERSIONS
VARIABLES COSTRUTTIVAS / VARIANTES DE CONSTRUCTIONS

CA

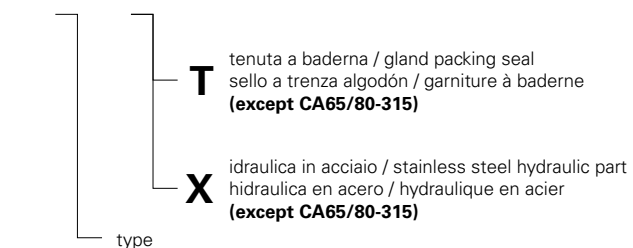

4CA

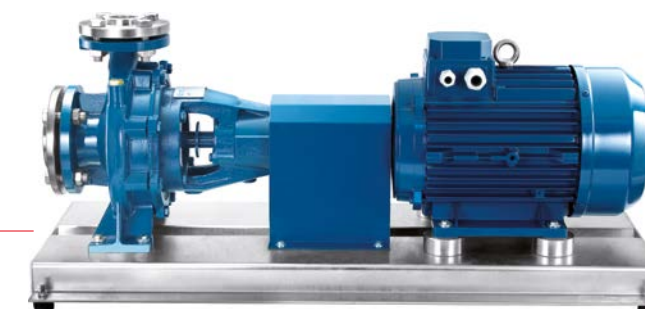
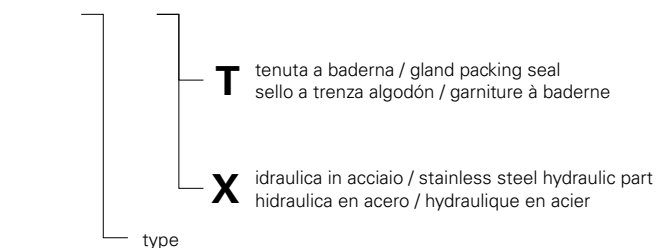

CA/CAT
4CA/4CAT

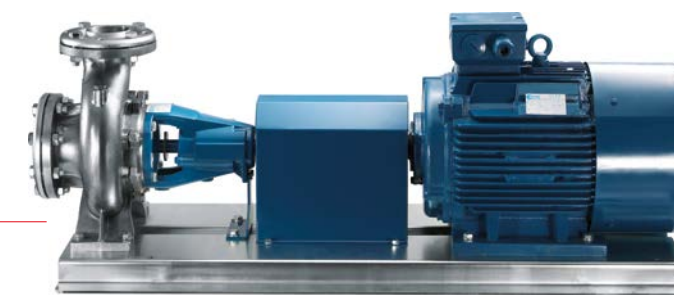

CAX
4CAX



CA/CAX
4CA/4CAX
tenuta meccanica
mechanical seal
sello mecánico
garniture mécanique



CAT
4CAT
tenuta a baderna
gland packing seal
sello a trenza algodón
garniture à baderne

32-160

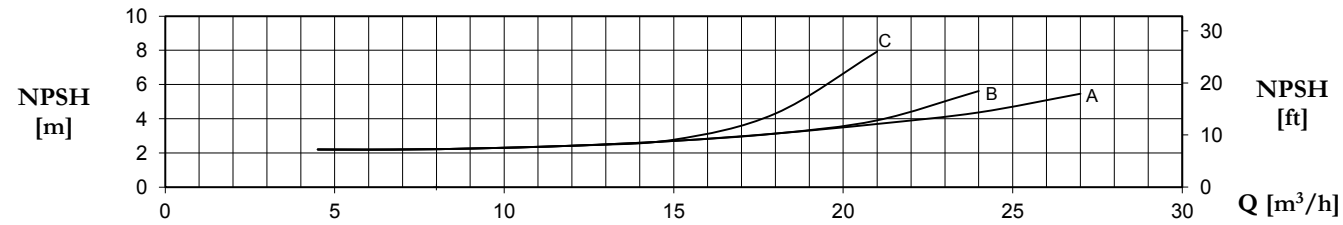
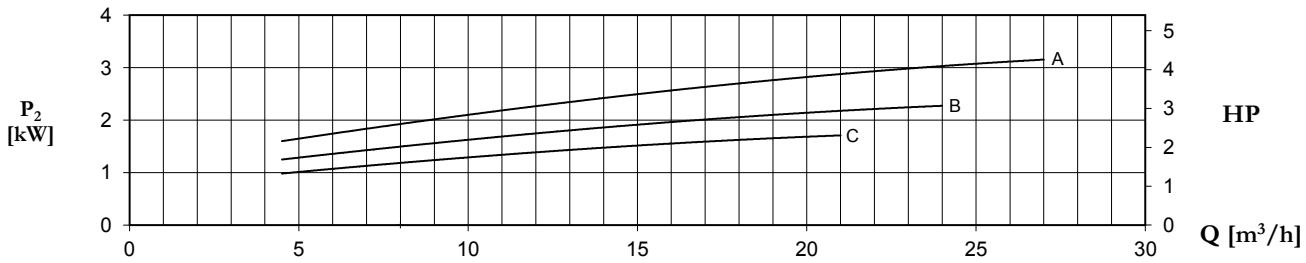
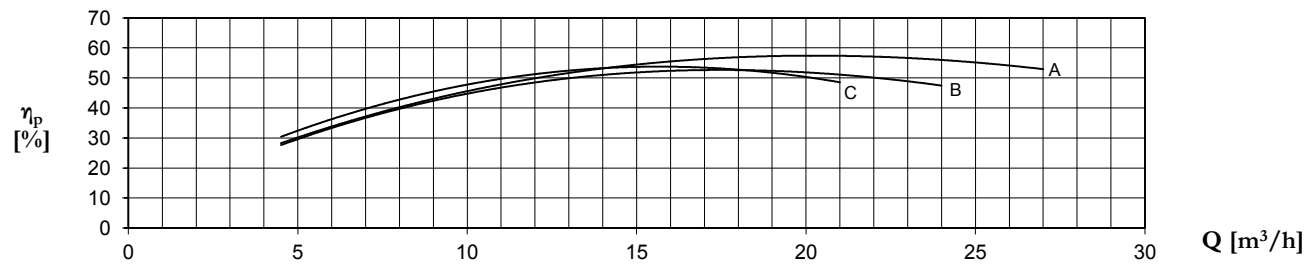
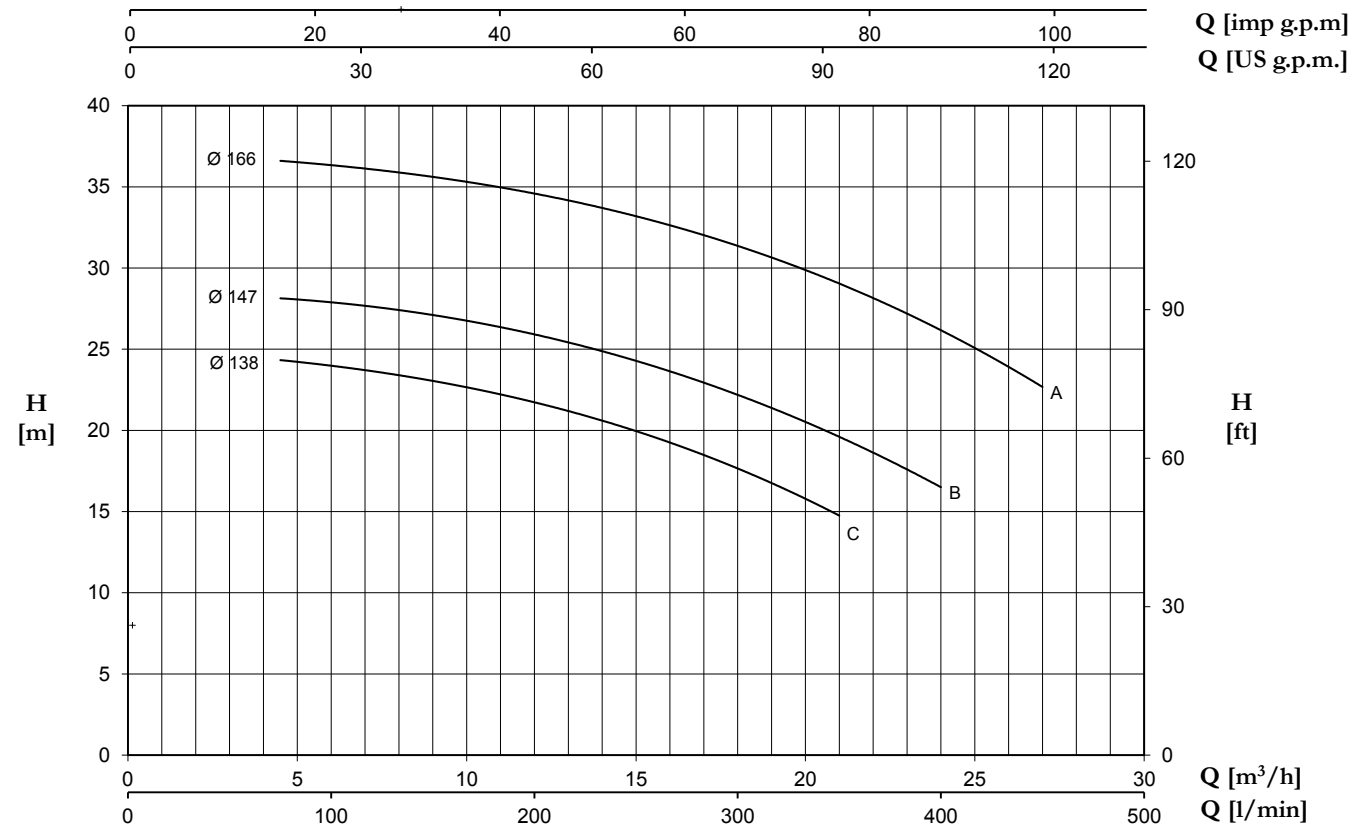

Tolerance: ISO 9906:2012 - Grade 3B

TYPE	Nominal Power (kW)	Motor Size	Q (m³/h - l/min)									
			0	4,5	6	9	12	15	18	21	24	27
			0	75	100	150	200	250	300	350	400	450
H (m) / pump input power (kW)												
32-160C	1,5	90S	24,4	24,3	24,0	23,0	21,8	20,0	17,5	14,8		
	2,2	90L	0,73	0,98	1,07	1,24	1,39	1,52	1,62	1,71		
32-160B	2,2	90L	28,1	28,2	27,9	27,0	25,9	24,4	22,2	19,5	16,6	
			0,97	1,25	1,36	1,56	1,75	1,92	2,06	2,17	2,28	
32-160A	3	100L	36,8	36,6	36,4	35,6	34,5	33,2	31,5	29,1	26,0	22,8
			1,24	1,61	1,74	2,01	2,27	2,50	2,70	2,88	3,03	3,16

32-200

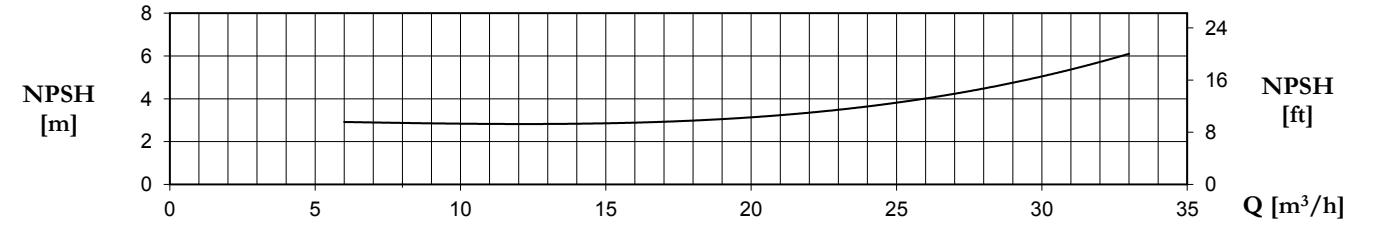
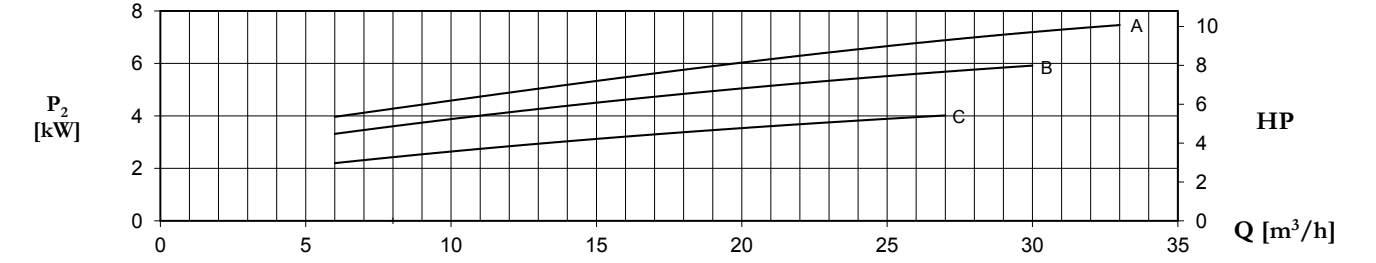
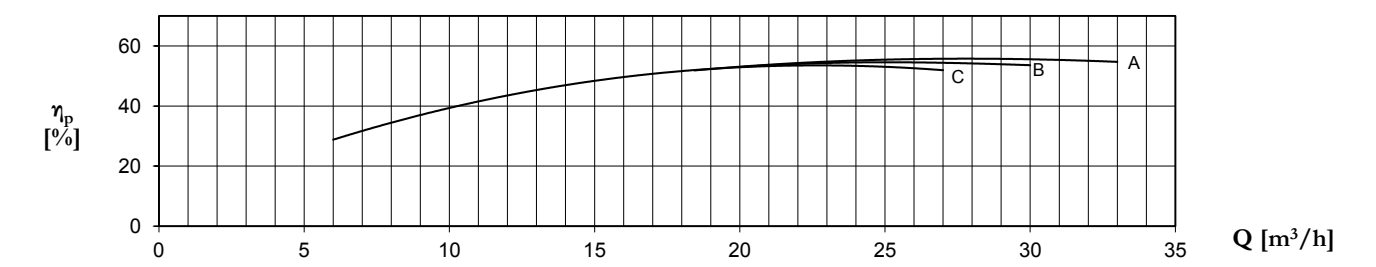
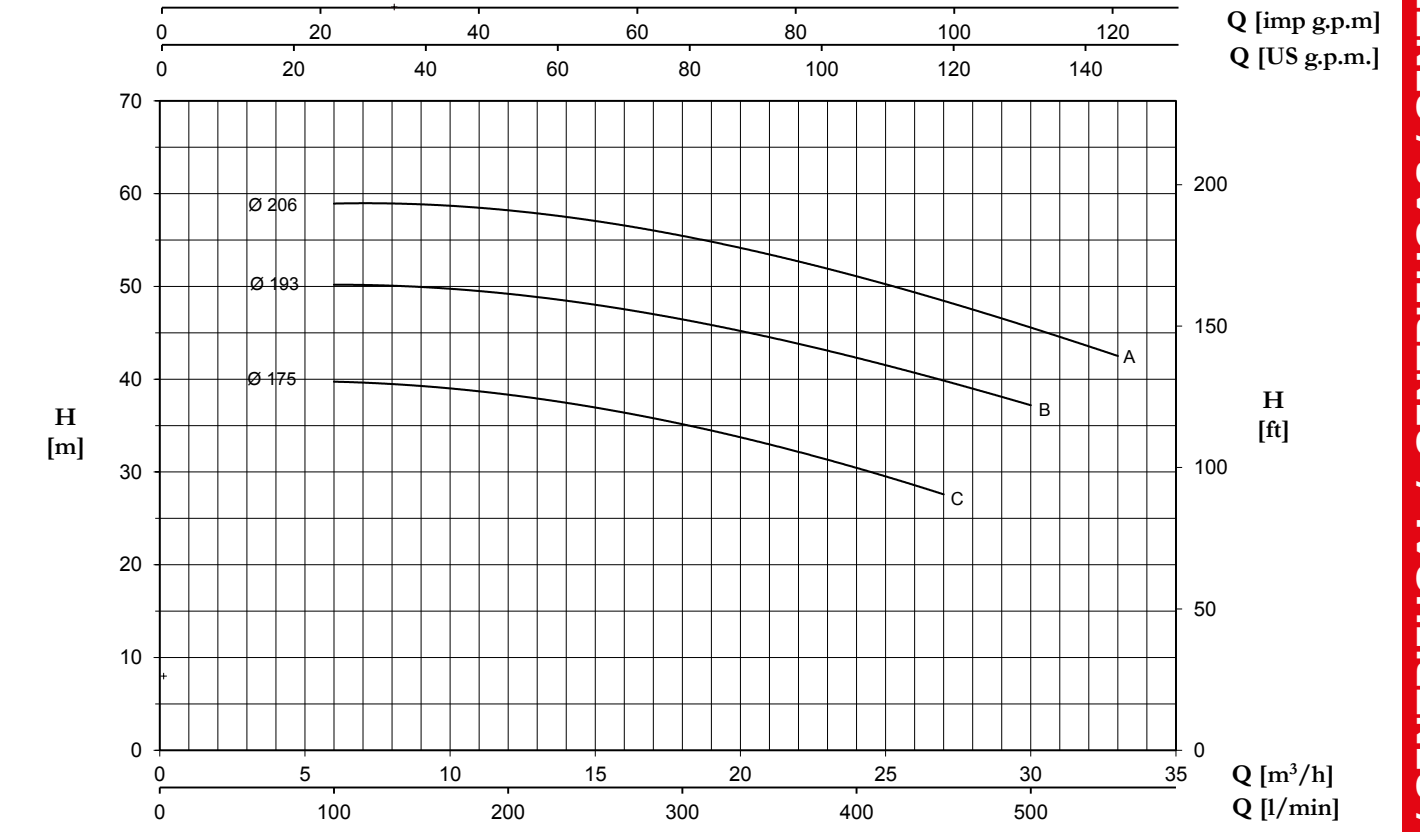

Tolerance: ISO 9906:2012 - Grade 3B

TYPE	Nominal Power (kW)	Motor Size	Q (m³/h - l/min)									
			0	6	9	12	15	21	24	27	30	33
			0	100	150	200	250	350	400	450	500	550
H (m) / pump input power (kW)												
32-200C	4	112M	40,1	39,7	39,3	38,3	36,9	33,0	30,4	27,6		
			1,52	2,20	2,53	2,84	3,13	3,61	3,82	4,02		
32-200B	5,5	132S	50,1	50,2	49,9	49,3	48,0	44,5	42,4	39,8	37,2	
			2,34	3,31	3,75	4,14	4,50	5,15	5,43	5,69	5,92	
32-200A	7,5	132S	58,6	59,0	58,8	58,2	57,1	53,4	51,1	48,4	45,6	42,5
			3,03	3,96	4,43	4,90	5,36	6,11	6,52	6,92	7,22	7,45

32-250

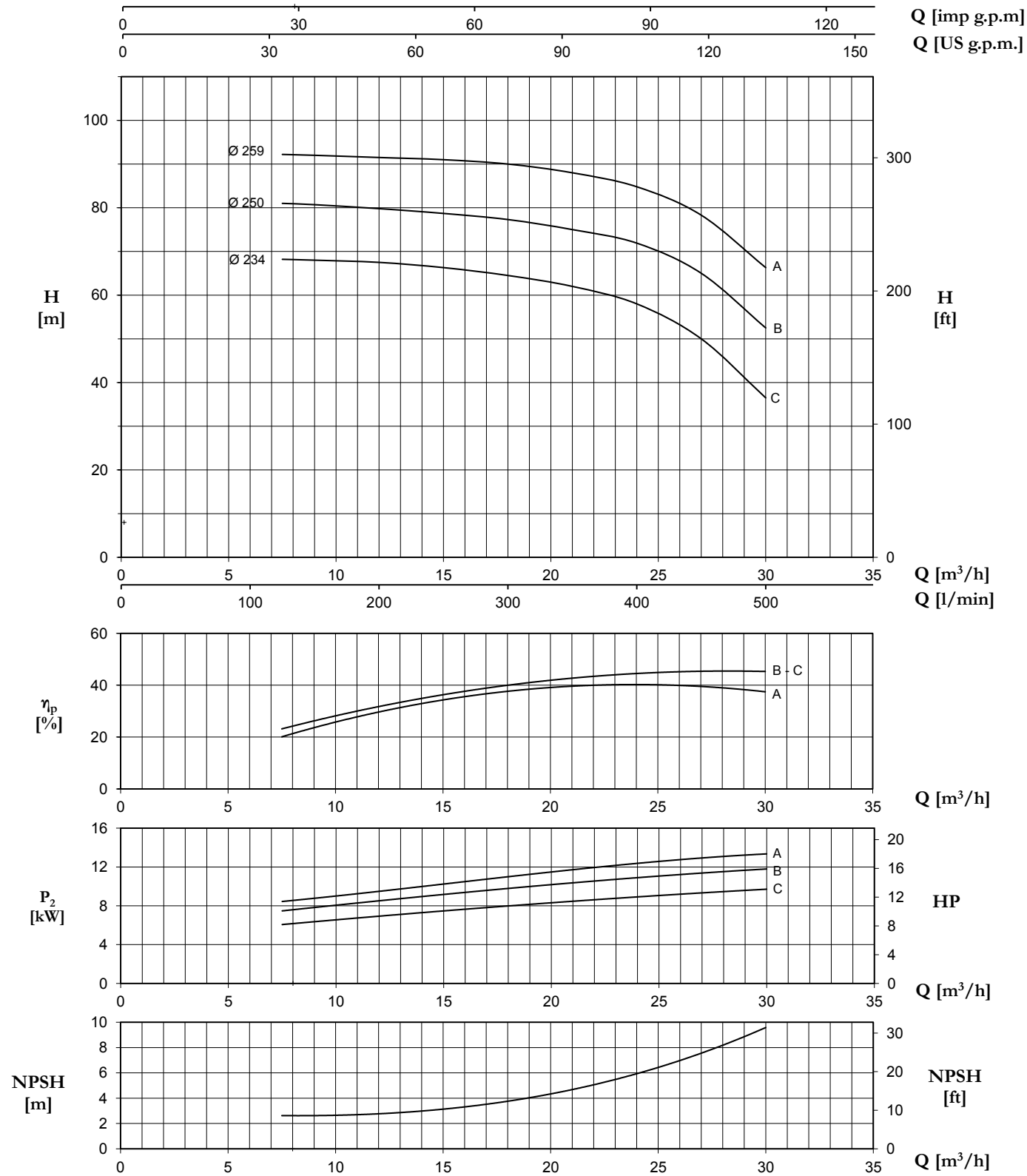

Tolerance: ISO 9906:2012 - Grade 3B

TYPE	Nominal Power (kW)	Motor Size	Q (m³/h - l/min)									
			0	7,5	9	12	15	18	21	24	27	30
			0	125	150	200	250	300	350	400	450	500
H (m) / pump input power (kW)												
32-250C	11	160M	70,0	68,5	68,0	67,0	65,5	63,5	61	58	50	36,5
			4,89	6,15	6,48	7,11	7,74	8,19	8,54	8,89	9,24	9,63
32-250B	11	160M	82,0	81,0	80,5	79,5	78,5	77,0	74,5	71,9	65	52,5
			6,45	8,02	8,35	9,00	9,56	10,1	10,5	11,2	11,8	12,1
32-250A	15	160M	93,0	92,5	92,0	91,5	90,5	89,5	87,5	85	78,5	66
			7,85	9,30	9,88	10,7	11,4	12,2	12,9	13,6	14,3	14,9

40-125

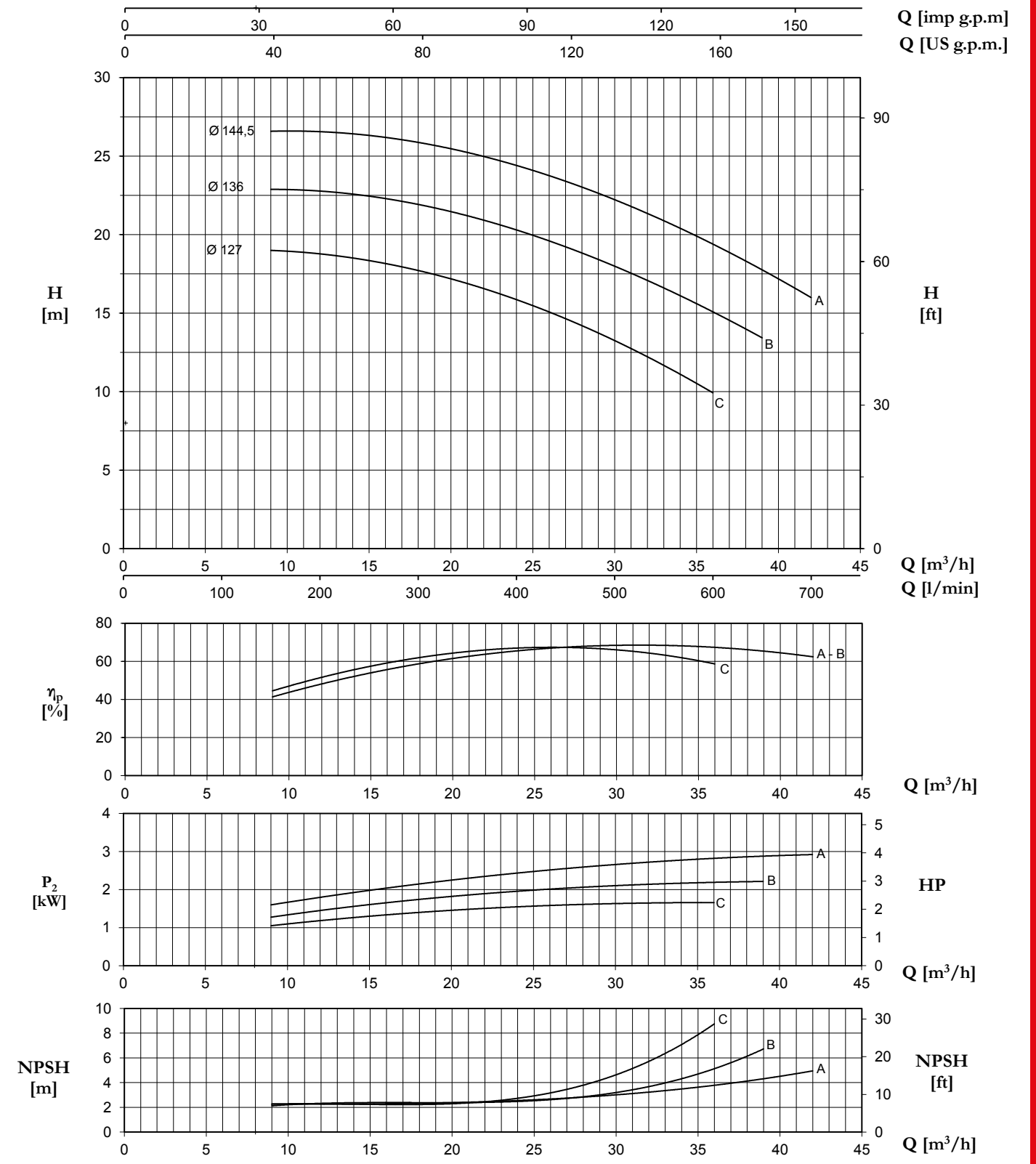

Tolerance: ISO 9906:2012 - Grade 3B

TYPE	Nominal Power (kW)	Motor Size	Q (m³/h - l/min)									
			0	9	15	21	27	33	36	39	42	
			0	150	250	350	450	500	550	600	650	700
H (m) / pump input power (kW)												
40-125C	1,5	90S	18,9	19,0	18,3	16,9	14,7	13,2	11,6	9,9		
			0,69	1,05	1,30	1,48	1,60	1,63	1,65	1,66		
40-125B	2,2	90L	22,5	22,9	22,5	21,2	19,2	18,0	16,7	15,2	13,4	
			0,86	1,28	1,60	1,86	2,04	2,10	2,15	2,19	2,22	
40-125A	3	100L	26,2	26,6	26,3	25,2	23,4	22,2	20,9	19,4	17,8	16,0
			1,11	1,60	1,98	2,30	2,55	2,66	2,75	2,82	2,87	2,92

40-160

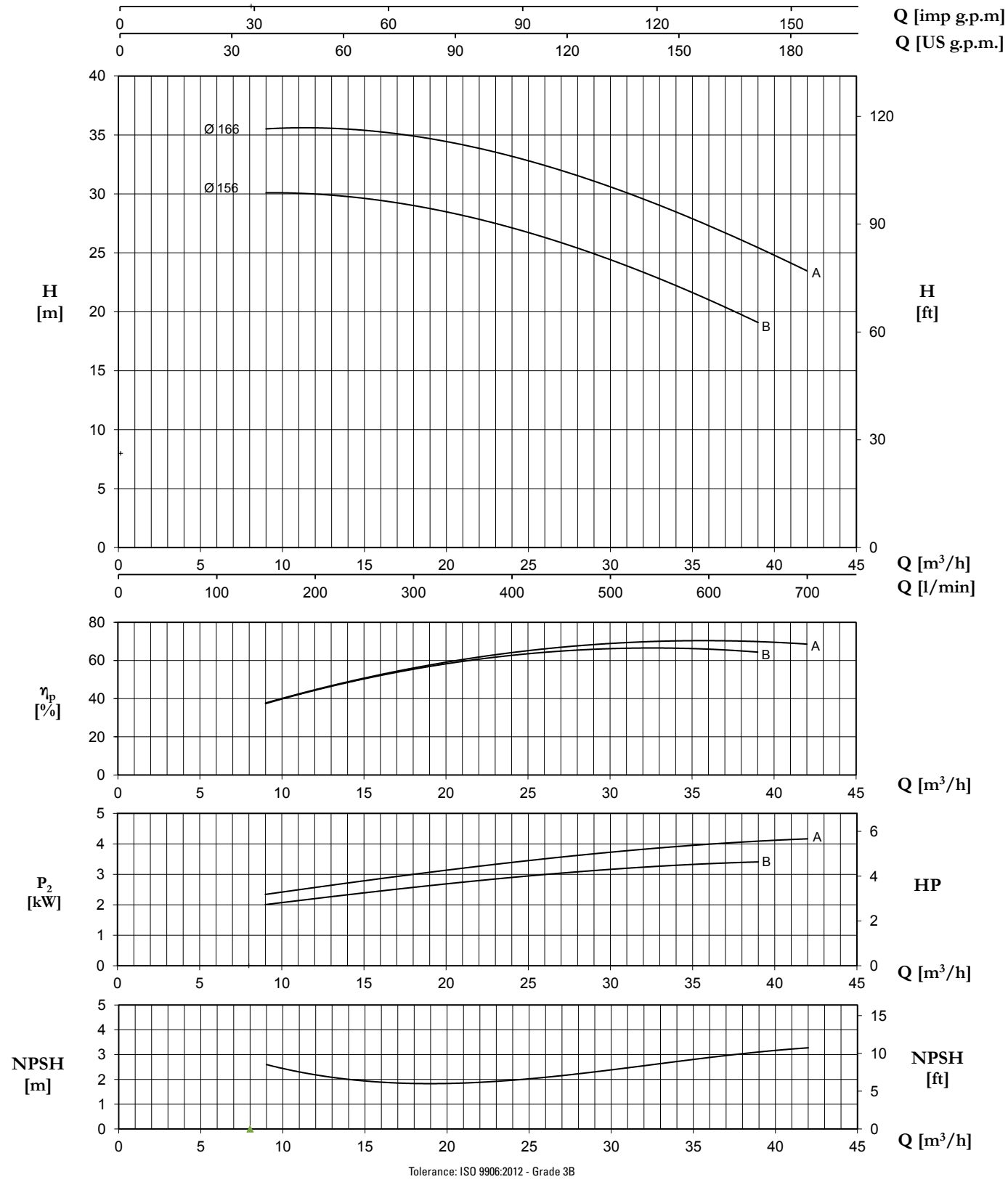

TYPE	Nominal Power (kW)	Motor Size	Q (m³/h - l/min)												
			0	9	12	15	18	21	24	27	30	33	36	39	42
			0	150	200	250	300	350	400	450	500	550	600	650	700
H (m) / pump input power (kW)															
40-160B	3	100L	30,0	30,1	30,0	29,6	29,0	28,2	27,1	25,9	24,4	22,8	21,0	19,1	
	4	112M	1,39	2,00	2,20	2,38	2,57	2,75	2,91	3,04	3,16	3,26	3,35	3,41	
40-160A	4	112M	35,4	35,6	35,5	35,3	35,0	34,2	33,2	32,0	30,6	29,0	27,3	25,4	23,5
	5,5	132S	1,64	2,36	2,55	2,78	3,00	3,21	3,40	3,56	3,72	3,86	3,99	4,08	4,17

40-200

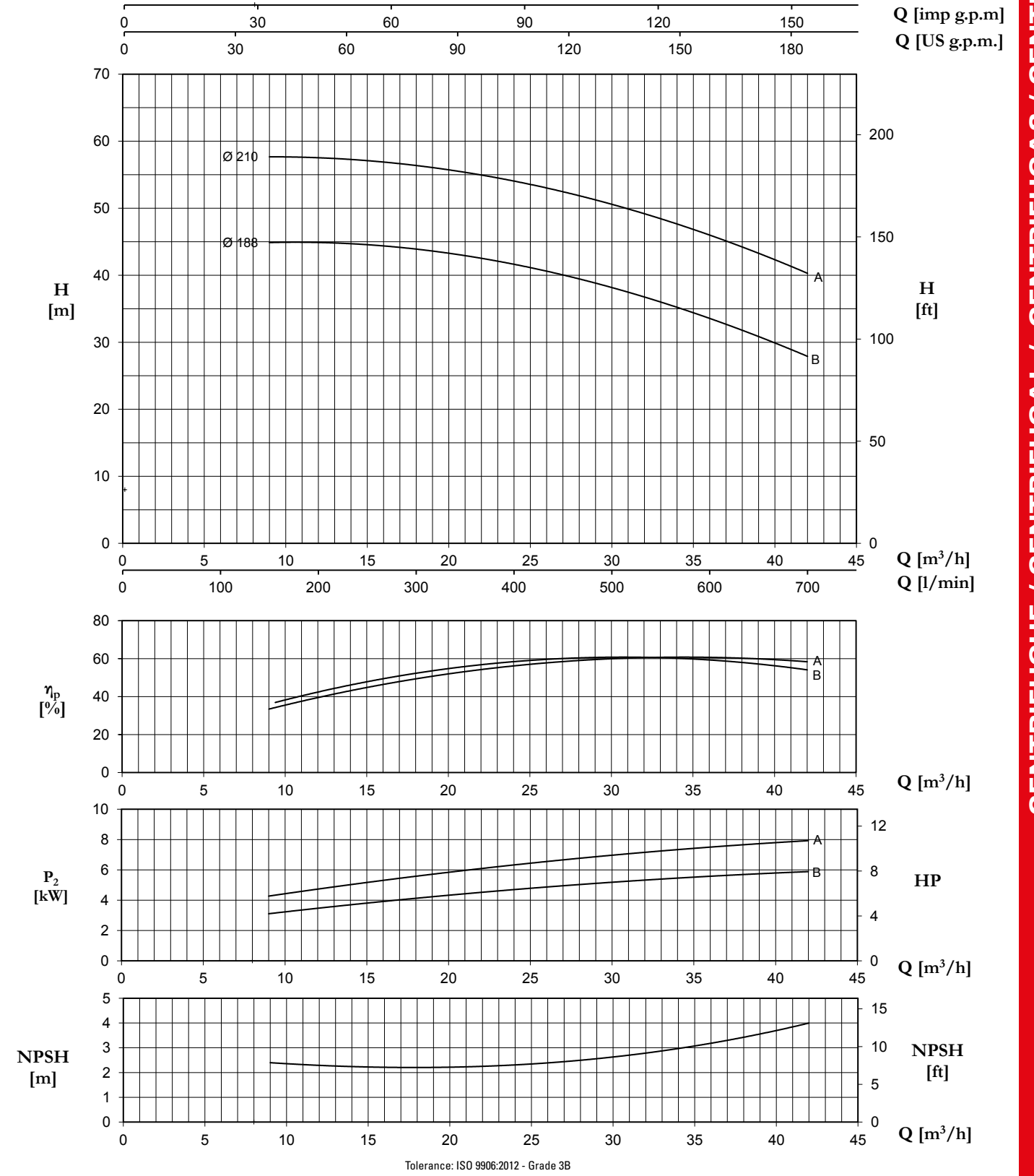

TYPE	Nominal Power (kW)	Motor Size	Q (m³/h - l/min)												
			0	9	12	15	18	21	24	27	30	33	36	39	42
			0	150	200	250	300	350	400	450	500	550	600	650	700
H (m) / pump input power (kW)															
40-200B	5,5	132S	44,7	44,9	44,8	44,6	44,0	42,9	41,6	40,0	38,1	36,1	33,6	30,8	27,9
			2,3	3,3	3,6	3,8	4,2	4,6	4,6	5,0	5,3	5,4	5,6	5,7	6,0
40-200A	7,5	132S	57,7	57,7	57,5	57,1	56,3	55,4	54,1	52,5	50,5	48,5	45,9	43,3	40,3
			3,2	4,3	4,6	5,2	5,6	6,1	6,4	6,7	7,1	7,4	7,6	7,9	8,0

40-250

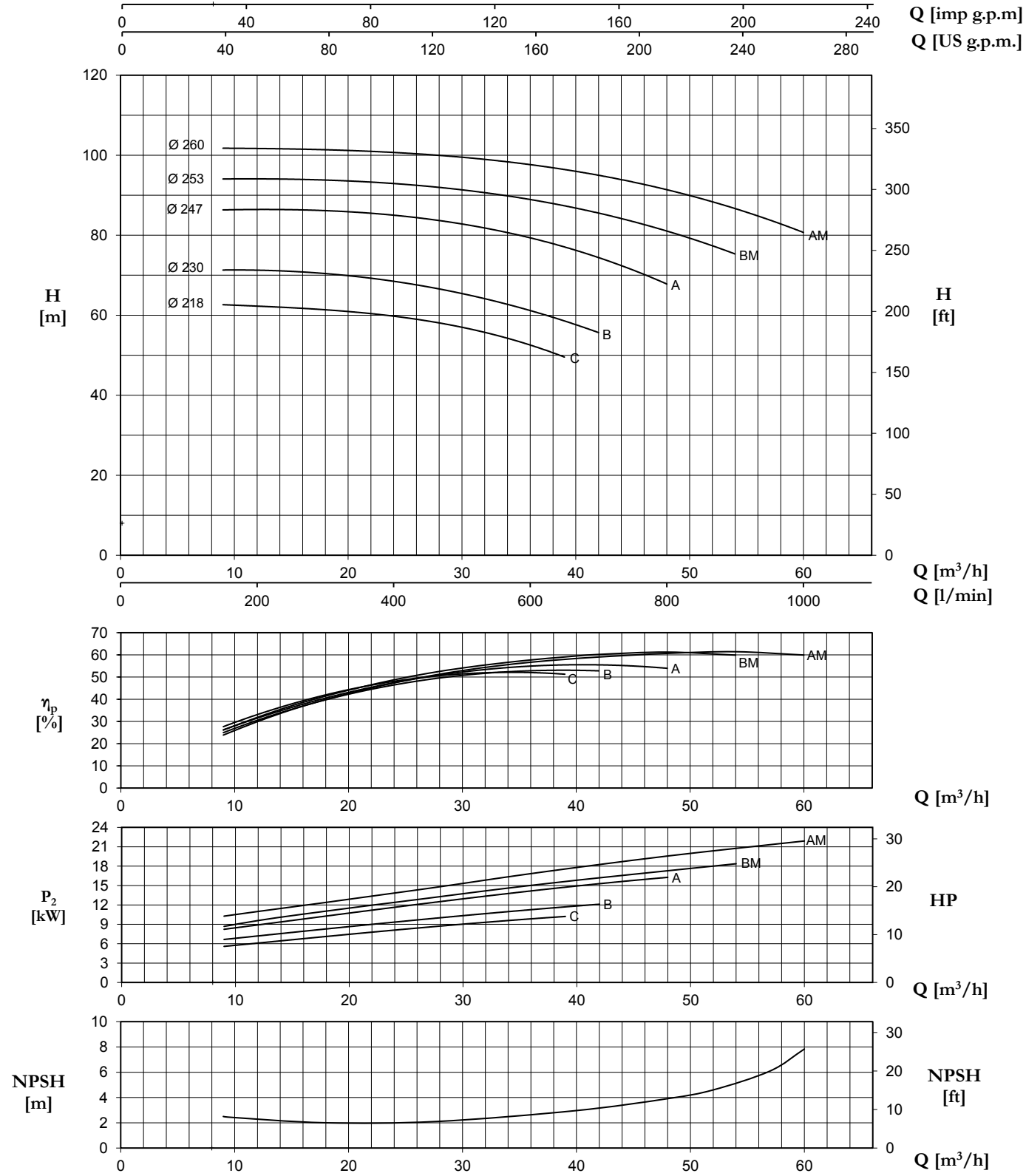

Tolerance: ISO 9906:2012 - Grade 3B

TYPE	Nominal Power (kW)	Motor Size	Q (m³/h - l/min)												
			H (m) / pump input power (kW)												
			0	9	15	21	27	36	39	42	48	54	60		
40-250C	11	160M	63,0	62,6	61,9	60,5	58,6	52,4	49,6						
			4,40	5,60	6,61	7,63	8,57	9,83	10,22						
40-250B	11	160M	70,8	71,3	71,0	69,8	66,6	61,2	58,5	55,6					
			5,16	6,65	7,76	8,80	9,86	11,25	11,69	12,11					
40-250A	15	160M	86,1	86,3	86,4	85,6	84,1	79,4	77,0	74,3	67,9				
			6,70	8,24	9,58	10,97	12,31	14,13	14,74	15,32	16,27				
40-250BM*	18,5	160L	93,1	93,8	94,2	93,4	92,2	88,8	87,3	85,6	81,4	75,1			
			6,81	8,68	10,35	11,73	13,06	15,03	15,63	16,20	17,29	18,37			
40-250AM*	22	180M	101,6	101,9	101,4	101,0	100,3	97,8	96,3	94,6	91,2	87,0	80,6		
			8,99	10,26	11,69	13,13	14,57	16,85	17,56	18,26	19,57	20,75	21,89		

(*) : max 14 bar

50-125

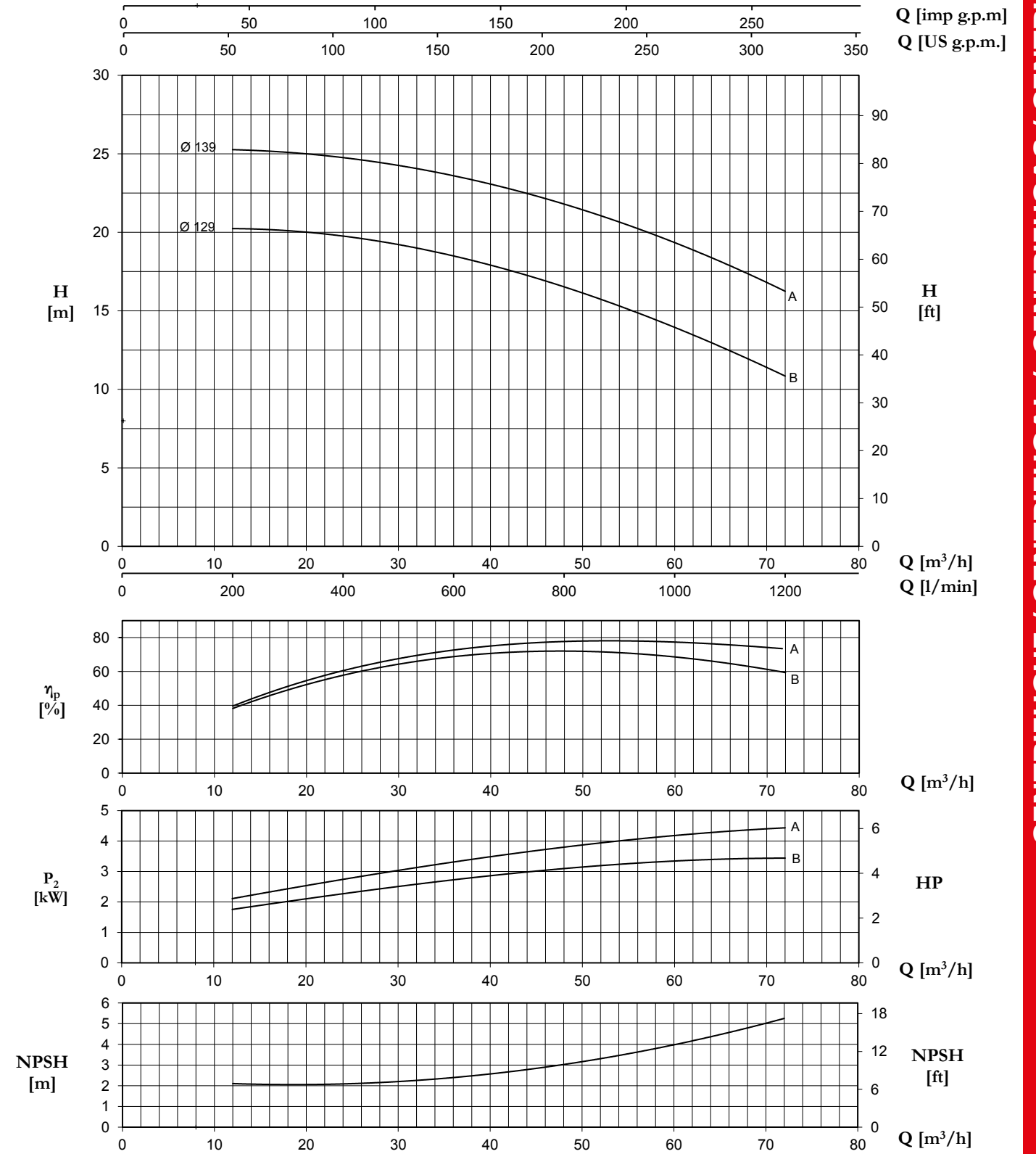

Tolerance: ISO 9906:2012 - Grade 3B

TYPE	Nominal Power (kW)	Motor Size	Q (m³/h - l/min)																
			H (m) / pump input power (kW)																
			0	12	15	18	21	24	27	30	33	36	39	42	48	54	60	66	72
50-125B	3	100L	19,9	20,2	20,2	20,1	20,0	19,8	19,3	19,1	18,7	18,3	17,8	17,4	16,4	15,3	14,0	12,7	11,2
			1,22	1,77	1,94	2,11	2,22	2,33	2,44	2,55	2,65	2,76	2,87	2,98	3,10	3,20	3,30	3,39	3,43
50-125A	4	112M	24,5		25,0	24,9	24,8	24,6	24,4	24,2	23,8	23,5	23,1	22,7	21,8	20,8	19,6	18,1	16,5
			1,78		2,54	2,70	2,85	3,01	3,17	3,33	3,42	3,50	3,59	3,67	3,77	3,87	4,14	4,42	4,58

50-160

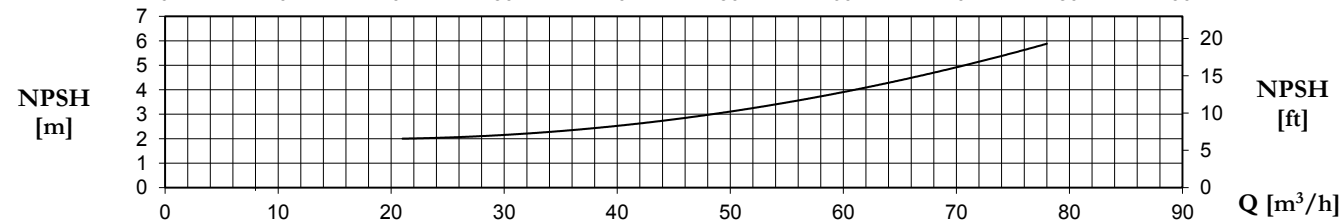
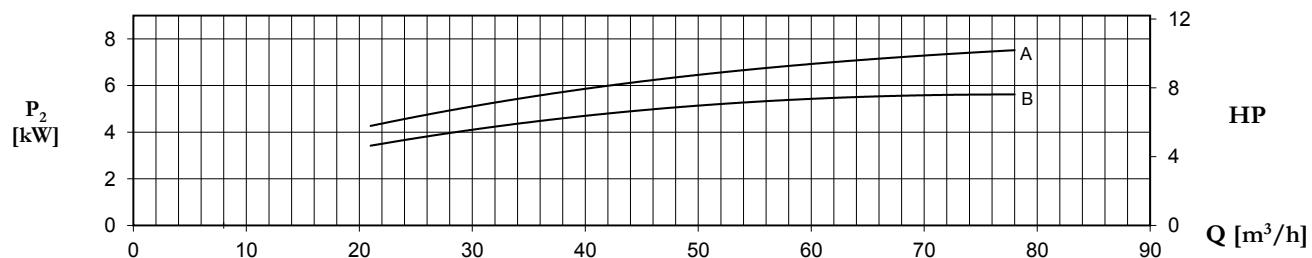
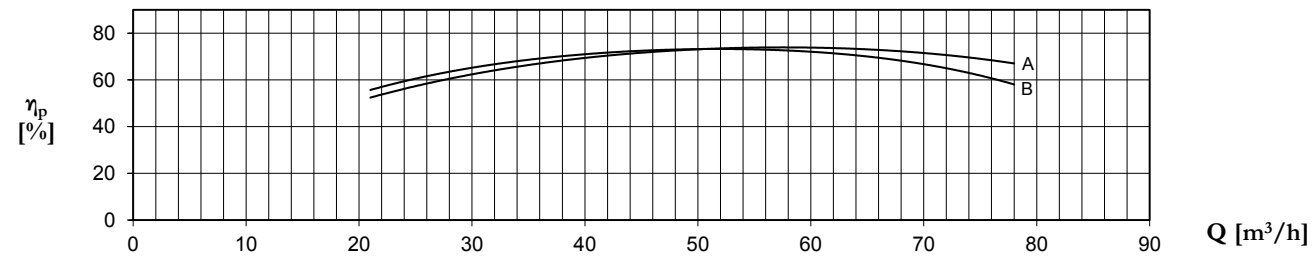
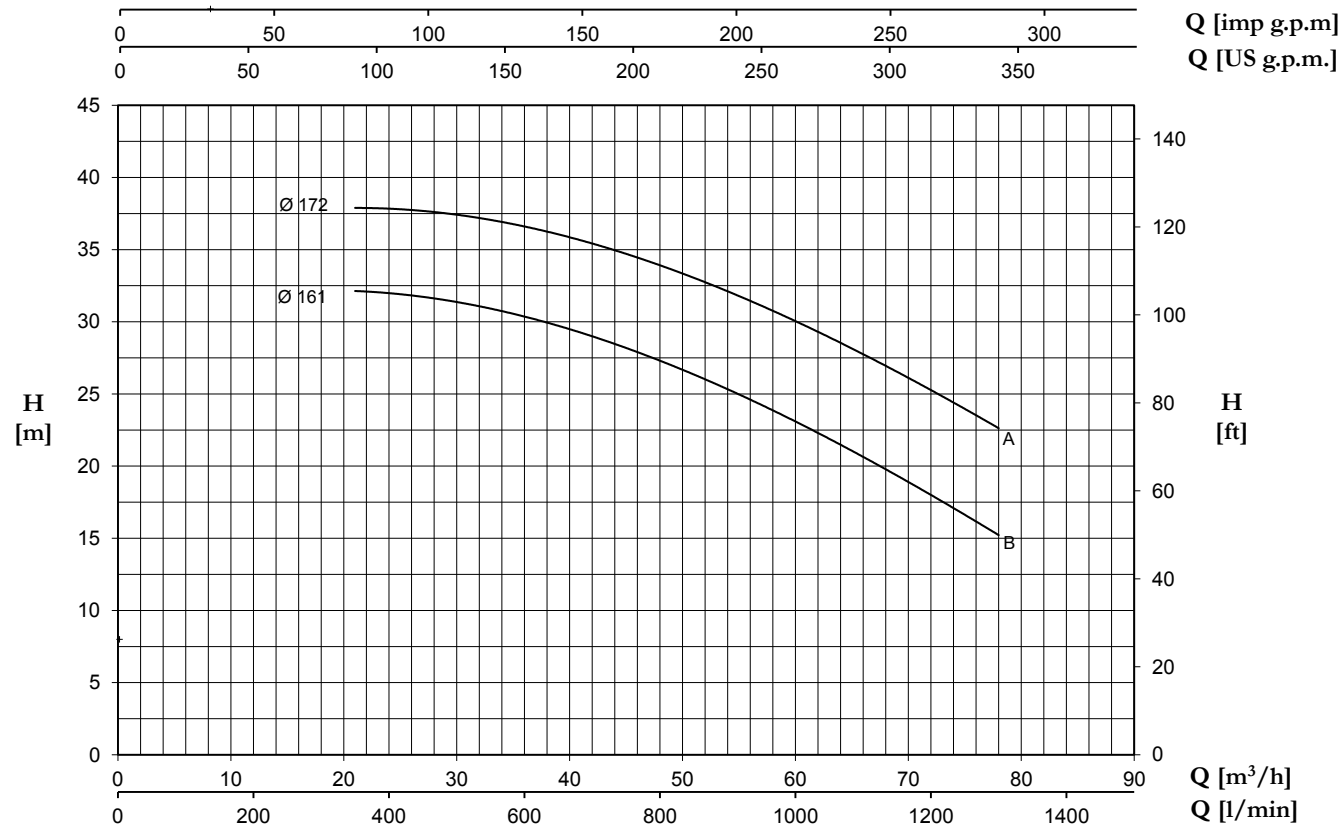

Tolerance: ISO 9906:2012 - Grade 3B

TYPE	Nominal Power (kW)	Motor Size	Q (m³/h - l/min)														
			H (m) / pump input power (kW)														
			0	21	24	27	30	33	36	39	42	48	54	60	66	72	78
50-160B	5,5	132S	31,1	32,1	32,0	31,7	31,4	31,0	30,4	29,7	28,9	27,3	25,3	23,1	20,7	18,0	15,2
50-160A	7,5	132S	36,7	37,9	37,8	37,7	37,4	37,1	36,6	36,1	35,4	33,9	32,1	30,0	27,8	25,3	22,6

50-200

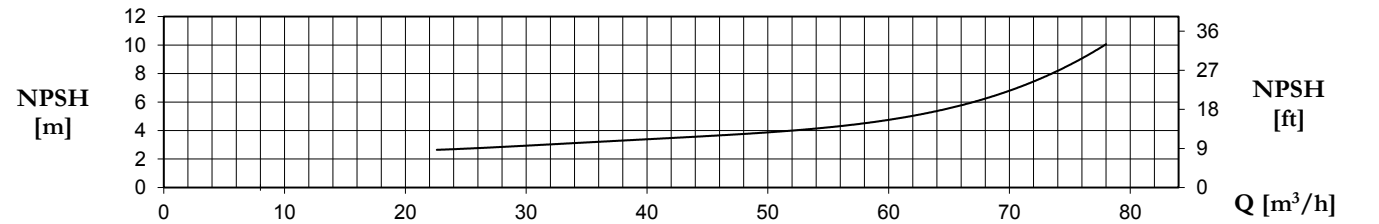
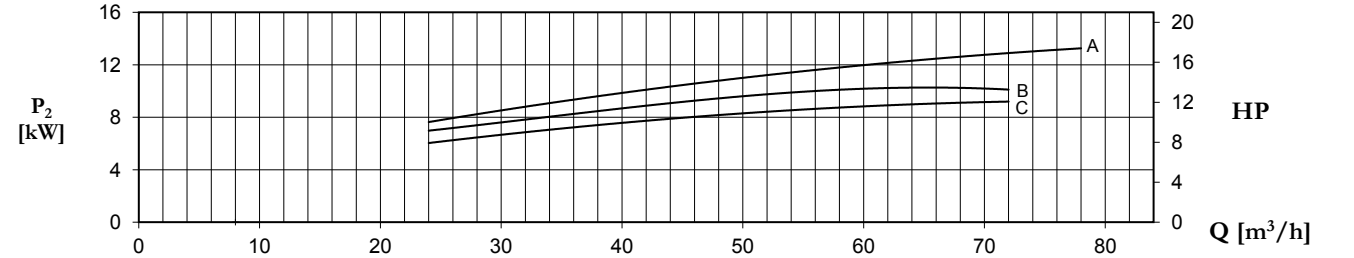
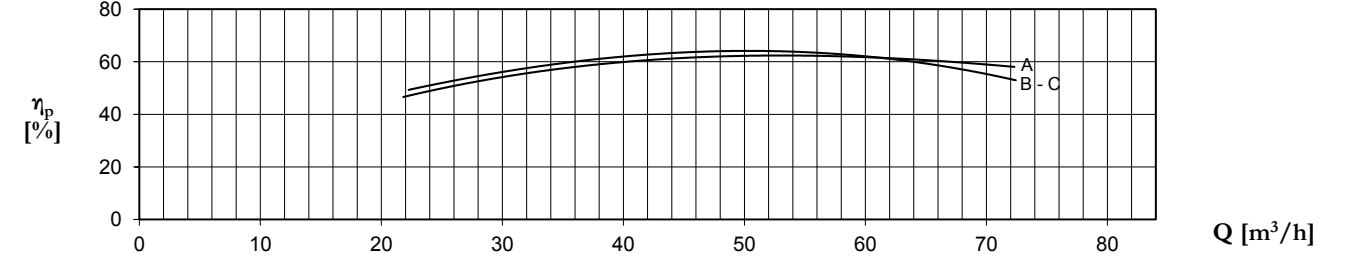
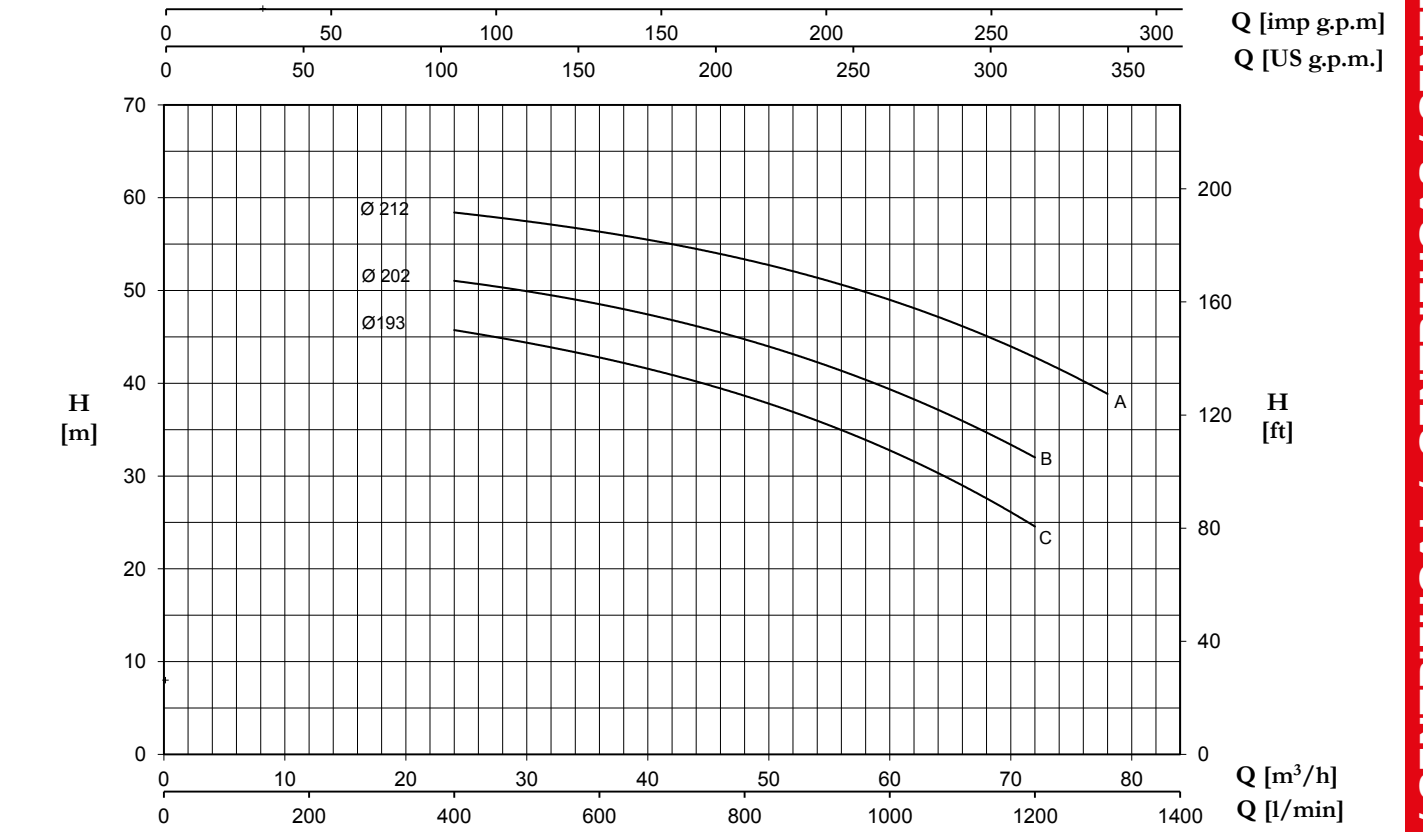

Tolerance: ISO 9906:2012 - Grade 3B

TYPE	Nominal Power (kW)	Motor Size	Q (m³/h - l/min)														
			H (m) / pump input power (kW)														
			0	24	27	30	33	36	39	42	48	54	60	66	72	78	
50-200C	11	160M	46,0	45,6	45,1	44,5	43,7	42,9	41,8	40,8	38,5	35,9	33,0	29,0	24,5		
50-200B	11	160M	50,8	51,0	50,5	50,0	49,3	48,5	47,7	46,8	44,7	42,2	39,5	35,9	32,0		
50-200A	15	160M	58,0	58,3	58,0	57,5	57,0	56,4	55,7	55,0	53,2	51,3	49,0	46,3	42,8	38,8	

CA/CAT - CAX EN 733 ~ 2900 r.p.m.

50-250

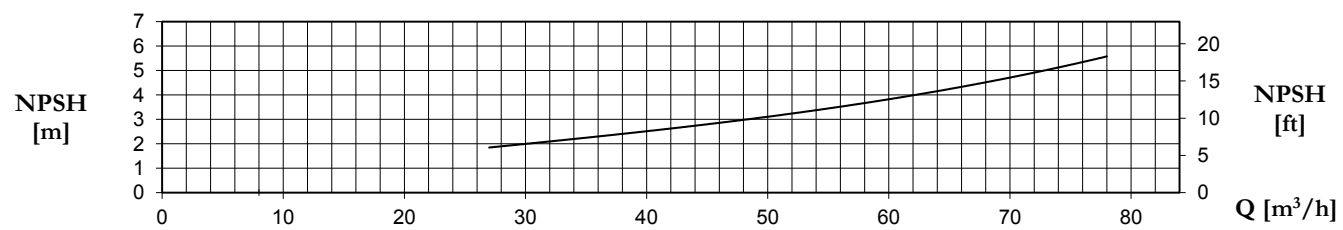
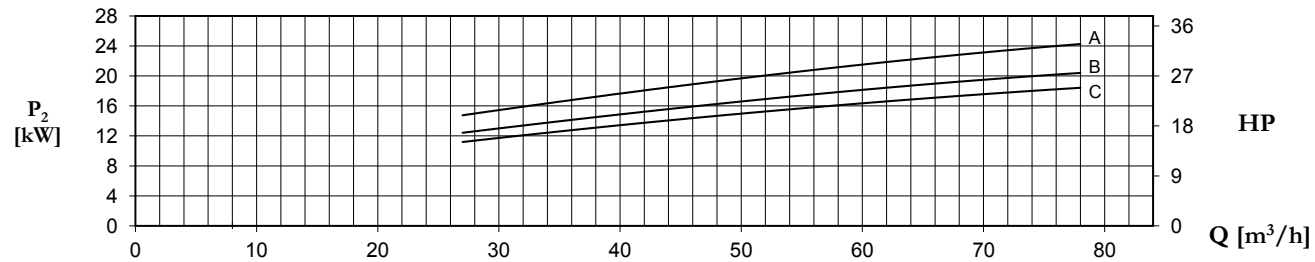
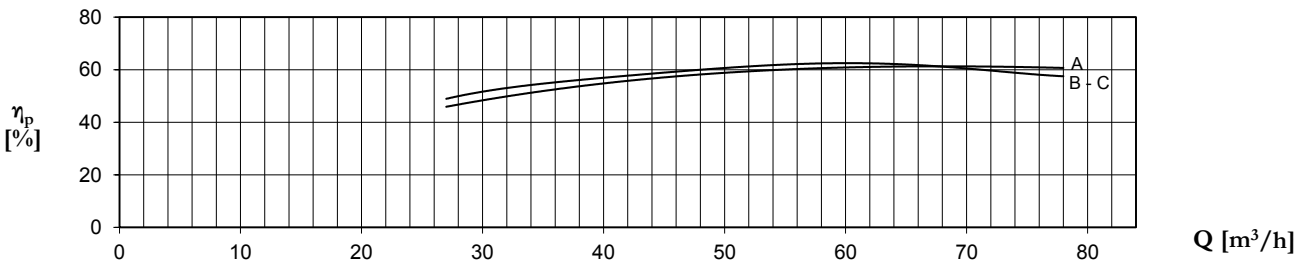
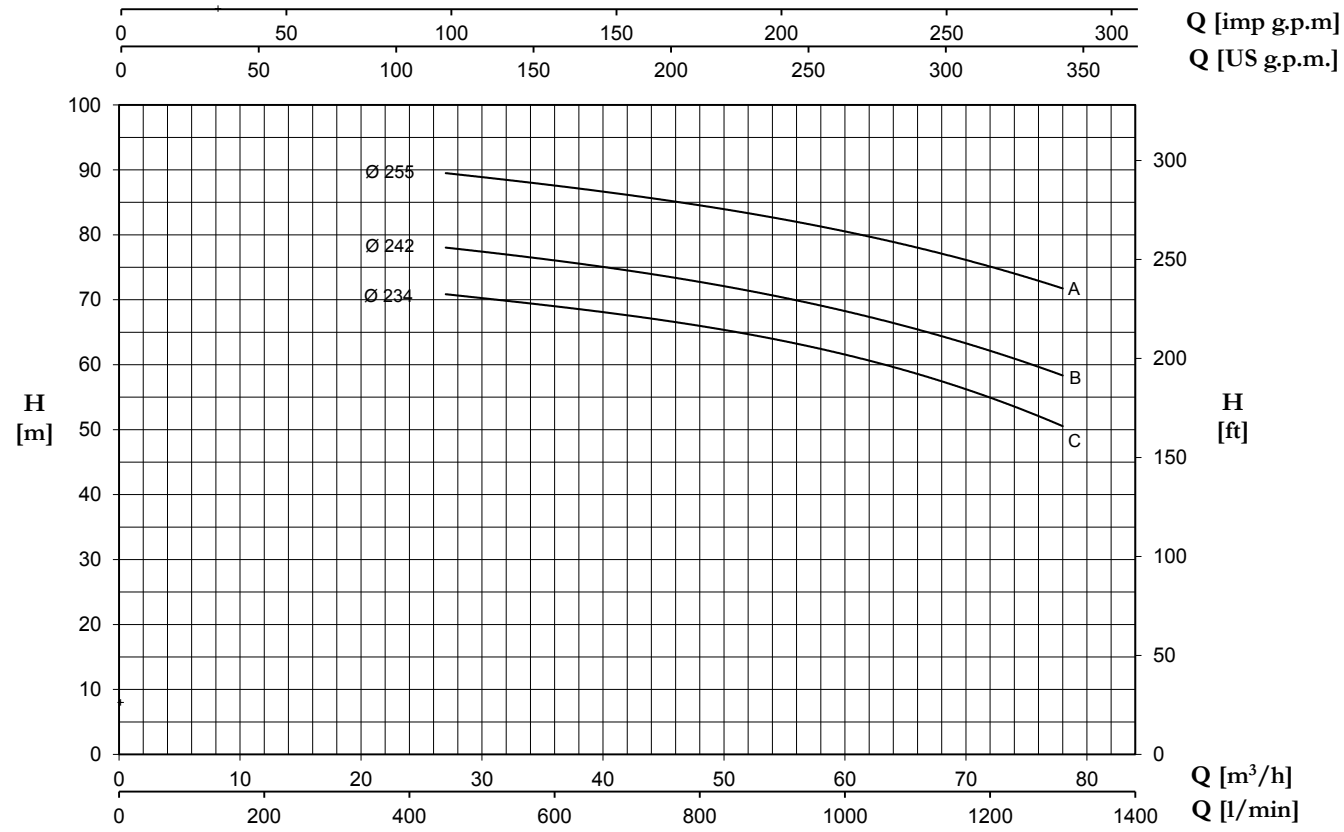

Tolerance: ISO 9906:2012 - Grade 3B

TYPE	Nominal Power (kW)	Motor Size	Q (m³/h - l/min)												
			0	27	30	33	36	39	42	48	54	60	66	72	78
			0	450	500	550	600	650	700	800	900	1000	1100	1200	1300
			H (m) / pump input power (kW)												
50-250C	15	160M	71,5	70,8	70,3	69,7	69,0	68,3	67,6	66,0	64,0	61,5	58,6	55,0	50,5
	18,5	160L	6,74	11,3	11,9	12,5	12,9	13,4	13,8	14,6	15,5	16,3	17,0	17,7	18,4
50-250B	18,5	160L	78,0	78,0	77,4	76,8	76,1	75,3	74,5	72,8	70,6	68,2	65,5	62,2	58,3
	22	180M	6,87	12,0	12,7	13,3	14,0	14,6	15,3	15,9	16,9	17,9	18,6	19,3	20,2
50-250A	22	180M	90,0	89,5	88,8	88,3	87,7	86,9	86,1	84,5	82,7	80,5	78,0	75,2	71,7
	30	200L	10,1	15,6	16,3	17,0	17,6	18,2	19,2	20,1	21,1	22,0	23,0	23,9	24,8

~ 2900 r.p.m. CA (No EN 733; only CA version)

50-315

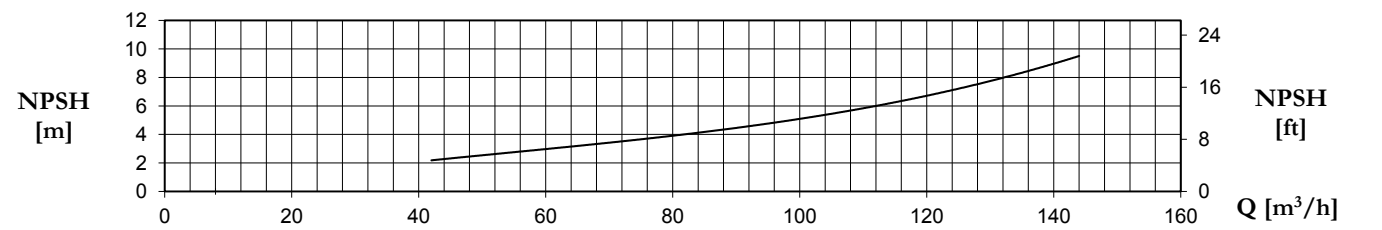
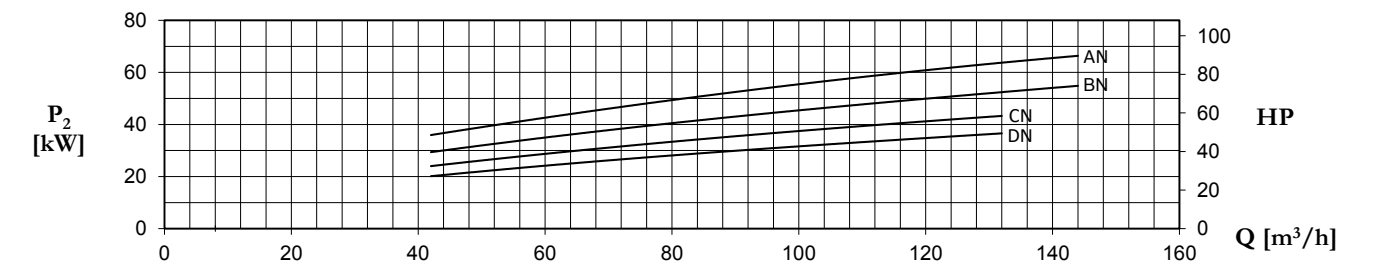
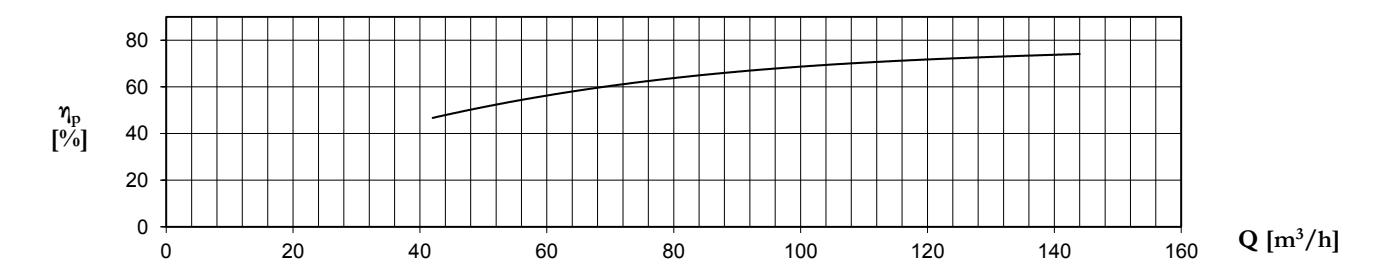
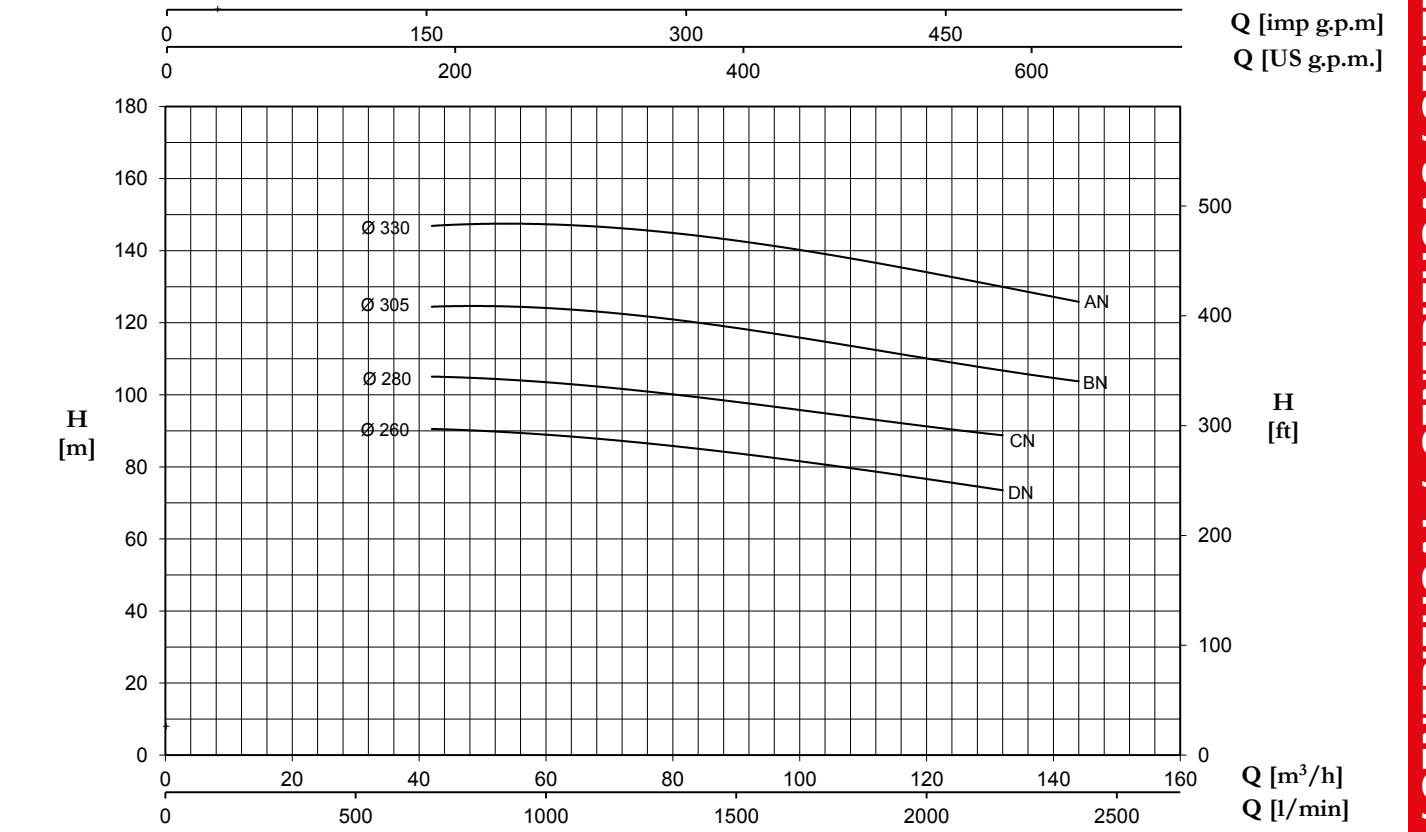

Tolerance: ISO 9906:2012 - Grade 3B

TYPE	Nominal Power (kW)	Motor Size	Q (m³/h - l/min)									
			0	42	54	66	78	96	120	132	144	
			0	700	900	1100	1300	1600	2000	2200	2400	
			H (m) / pump input power (kW)									
50-315DN	37	200L	87,8	90,4	89,9	88,2	86,0	82,4	76,9	73,4		
			11,19	20,11	22,91	25,41	27,71	30,91	34,81	36,56		
50-315CN	45	225M	101,8	105,0	104,3	102,7	100,3	96,7	91,3	88,7		
			13,32	23,97	27,25	30,21	32,85	36,68	41,26	43,26		
50-315BN	55	250M	122,3	124,3	124,7	123,6	121,3	116,6	110,1	107,1	103,5	
			17,44	29,30	33,28	36,80	39,85	44,41	50,01	52,39	54,83	
50-315AN	75	280S	146,1	146,9	147,4	146,9	145,3	141,2	134,1	130,0	125,8	
			22,75	35,89	40,53	44,71	48,67	54,26	60,84	63,78	66,34	

65-125

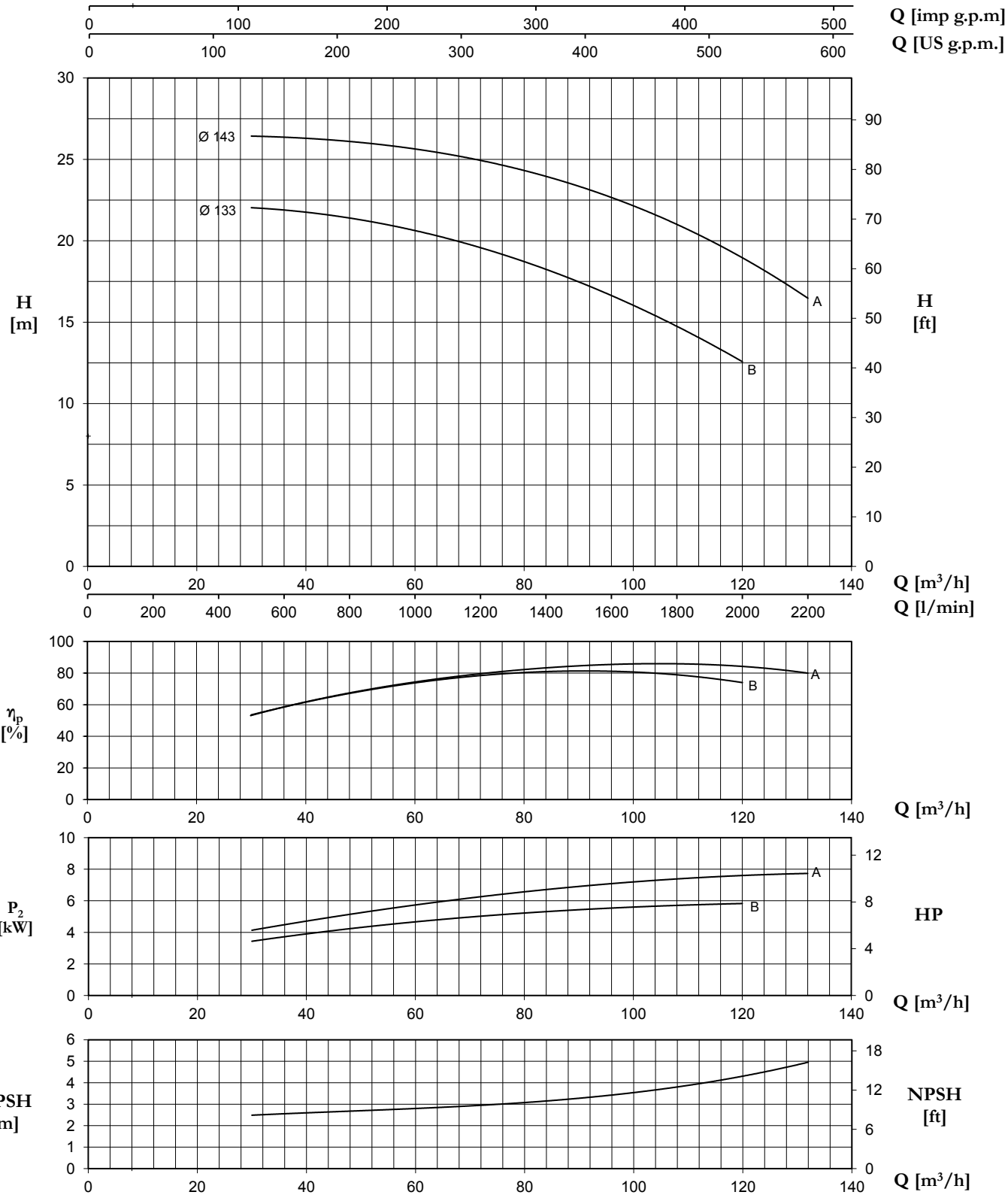

Tolerance: ISO 9906:2012 - Grade 3B

TYPE	Nominal Power (kW)	Motor Size	Q (m ³ /h - l/min)															
			H (m) / pump input power (kW)															
			0	30	33	36	39	42	48	54	60	66	72	78	84	96	108	120
65-125B	5,5	132S	20,9	22,0	22,0	21,9	21,8	21,7	21,4	21,0	20,6	20,1	19,6	19,0	18,3	16,6	14,7	12,6
65-125A	7,5	132S	25,4	26,4	26,4	26,4	26,3	26,3	26,1	25,9	25,6	25,3	24,9	24,5	24,0	22,7	21,0	18,9

65-160

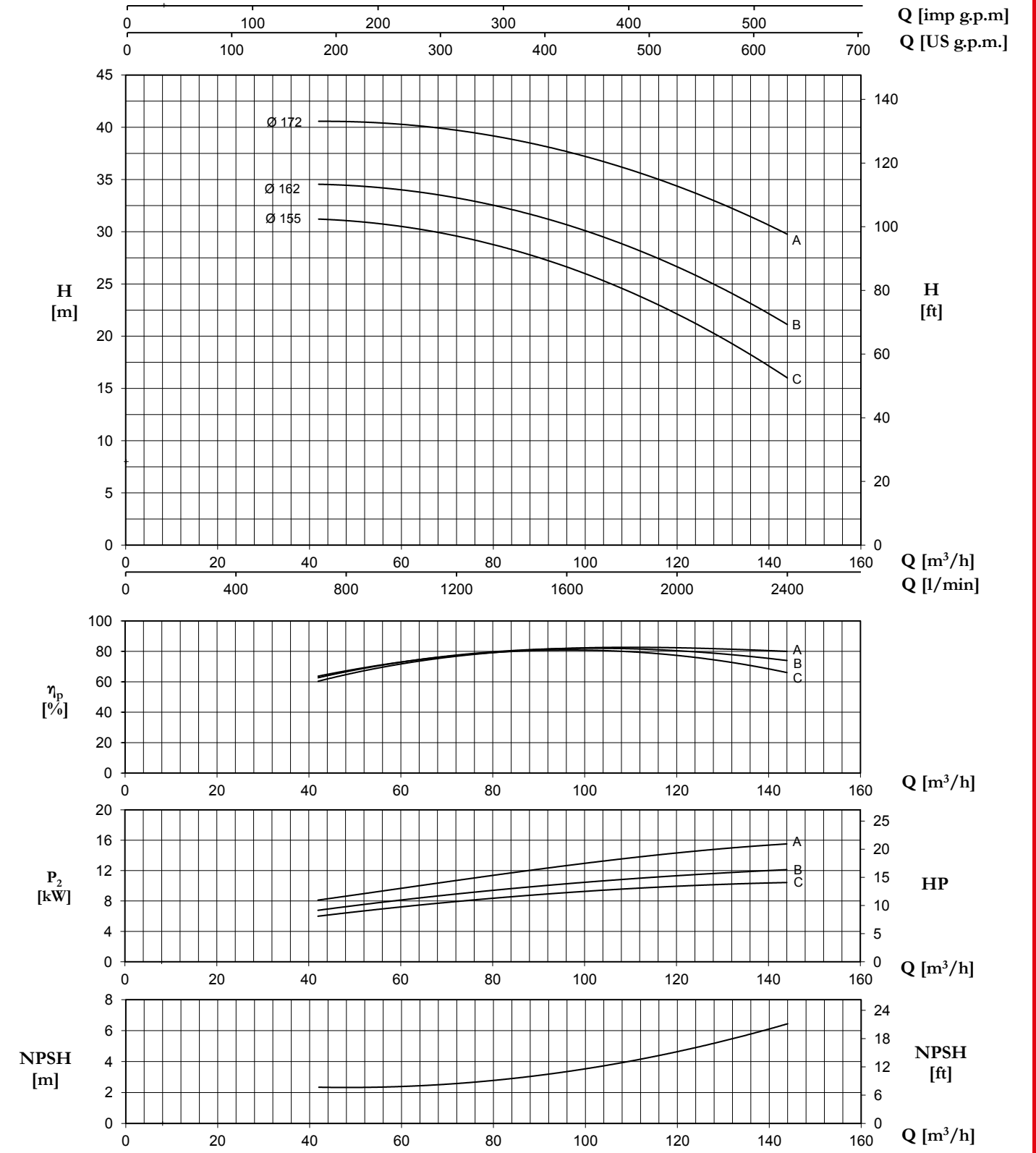

Tolerance: ISO 9906:2012 - Grade 3B

TYPE	Nominal Power (kW)	Motor Size	Q (m ³ /h - l/min)											
			H (m) / pump input power (kW)											
			0	42	48	60	72	78	84	108	132	144		
65-160C	11	160M	29,8	31,2	31,1	30,5	29,6	29,0	28,3	24,6	19,3	16,0		
65-160B	11	160M	33,0	34,6	34,4	34,0	33,3	32,8	32,1	28,8	24,1	21,1		
65-160A	15	160M	39,2	40,6	40,6	40,2	39,7	39,4	38,9	36,2	32,2	29,8		

65-200

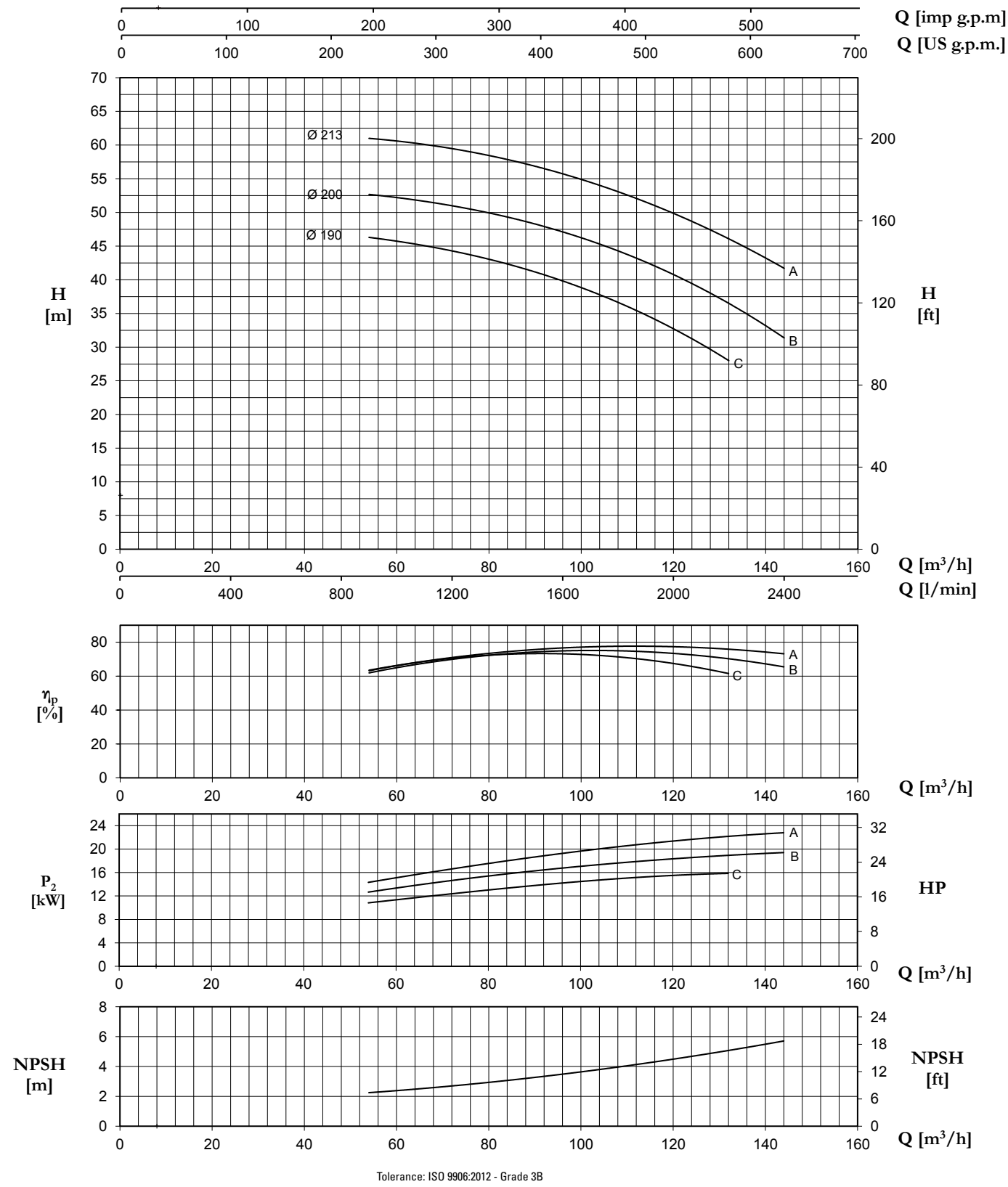

TYPE	Nominal Power (kW)	Motor Size	Q (m³/h - l/min)											
			H (m) / pump input power (kW)											
			0	54	60	66	72	78	84	96	108	120	132	144
65-200C	15	160M	45,3	46,3	45,7	45,1	44,3	43,4	42,3	39,8	36,7	32,7	28,0	
65-200B	18,5	160L	51,6	52,6	52,2	51,8	51,0	50,2	49,3	47,1	44,1	40,9	36,6	31,3
65-200A	22	180M	60,2	61,0	60,6	60,1	59,5	58,7	57,8	55,8	53,1	49,8	46,1	41,7

65-250

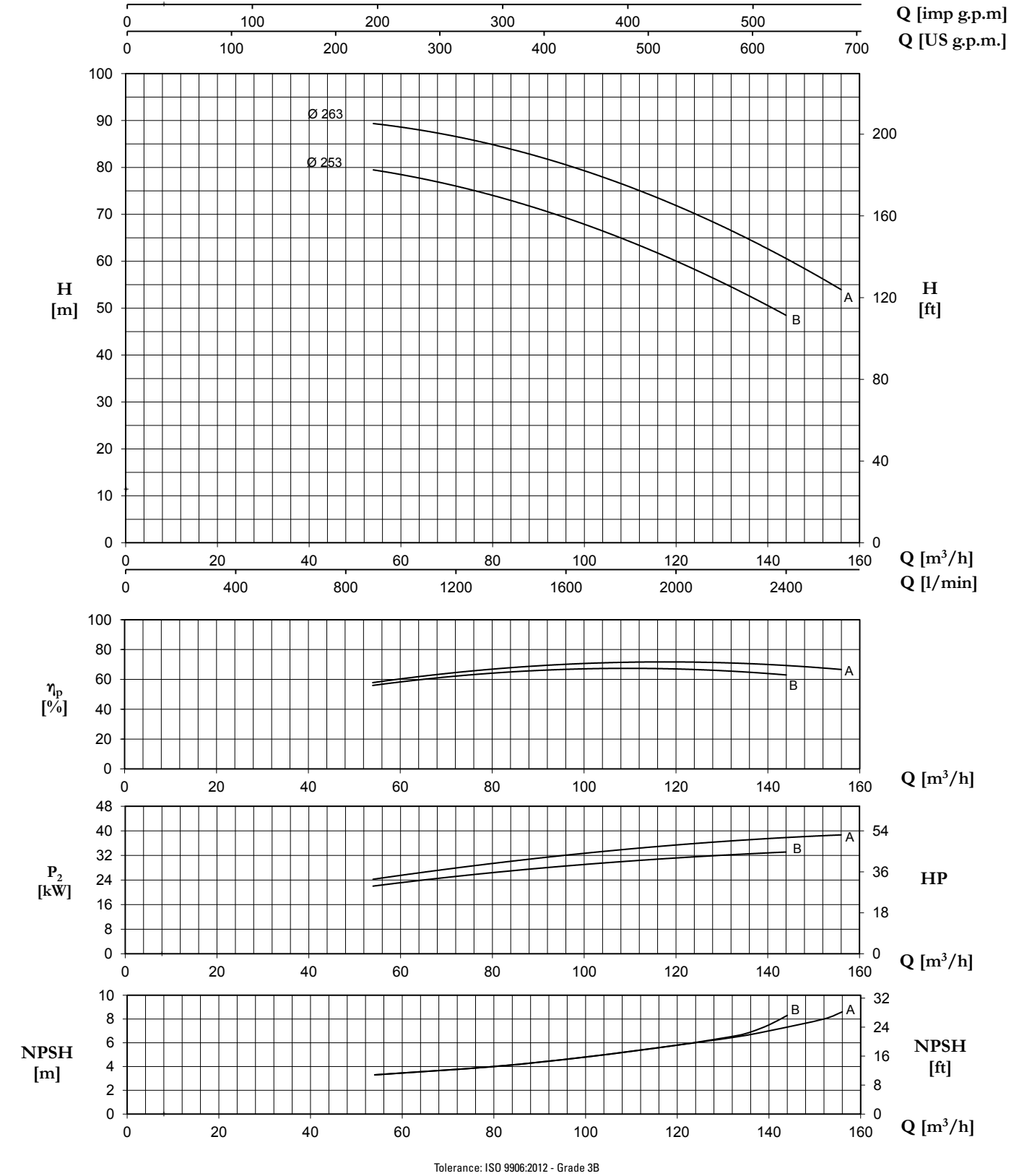

TYPE	Nominal Power (kW)	Motor Size	Q (m³/h - l/min)												
			H (m) / pump input power (kW)												
			0	54	60	66	72	78	84	96	108	120	132	144	156
65-250B	30	200L	81,0	79,5	78,5	77,3	76,0	74,5	73,0	69,3	65,0	60,0	54,5	48,5	
65-250A	37	200L	90,0	89,5	88,5	87,5	86,5	85,5	84,0	80,5	76,5	72,0	66,5	60,5	

65-315

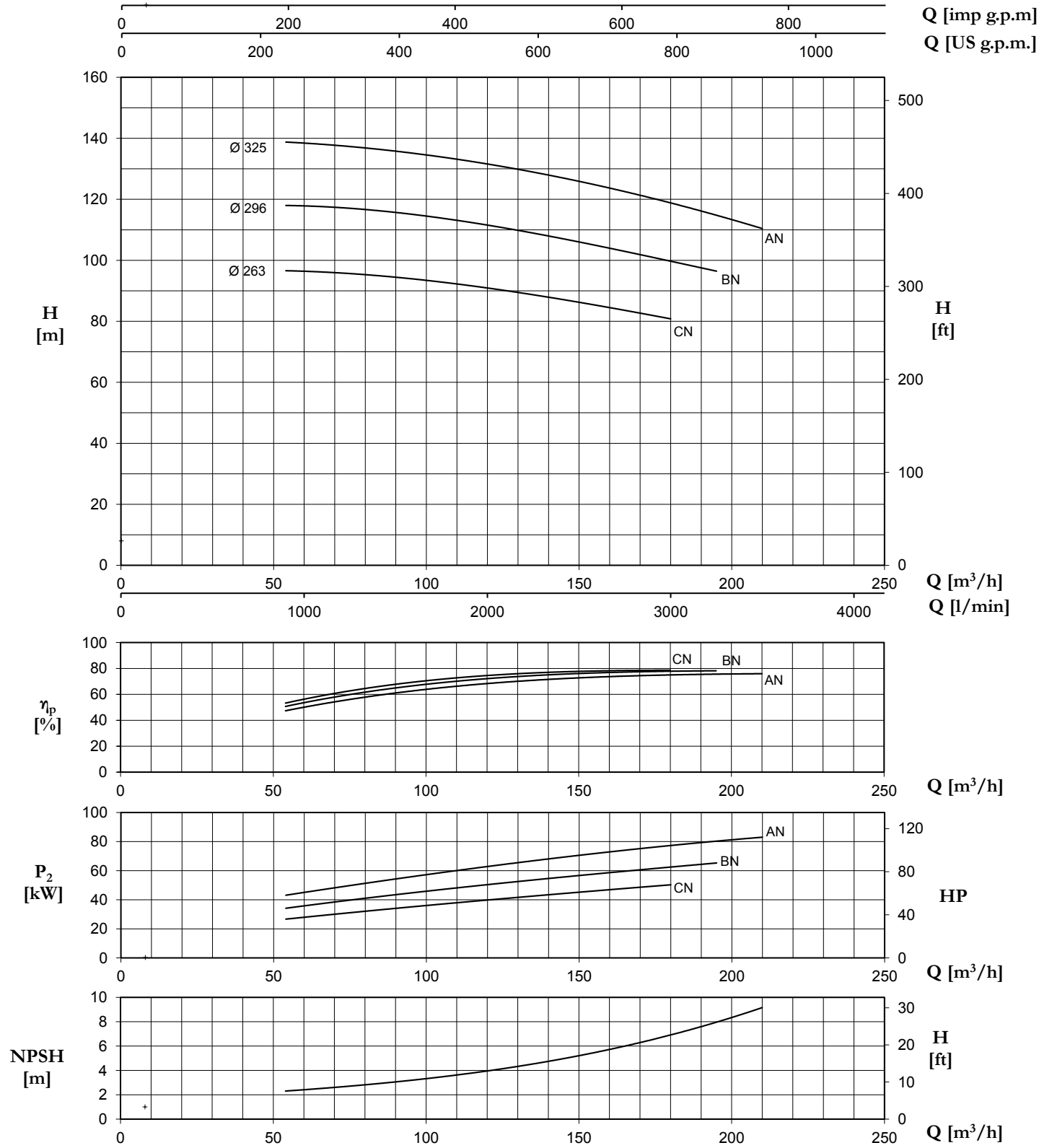

Tolerance: ISO 9906:2012 - Grade 3B

TYPE	Nominal Power (kW)	Motor Size	Q (m³/h - l/min)											
			0	54	66	78	96	120	144	180	195	210		
			0	900	1100	1300	1600	2000	2400	3000	3250	3500		
H (m) / pump input power (kW)														
65-315CN	55	250M	93,9 15,58	96,5 26,64	96,3 29,26	95,6 31,67	93,8 35,28	90,7 39,76	87,5 44,18	80,8 50,27				
65-315BN	75	280S	116,5 21,16	117,9 34,28	117,7 37,35	117,0 40,26	114,9 45,05	111,4 50,51	107,2 55,48	99,9 62,26	96,3 65,43			
65-315AN	90	280M	138,2 26,69	138,8 43,17	138,1 46,88	137,0 50,67	135,0 56,09	131,7 62,82	127,0 69,20	118,8 77,32	114,8 80,16	110,4 83,11		

80-160

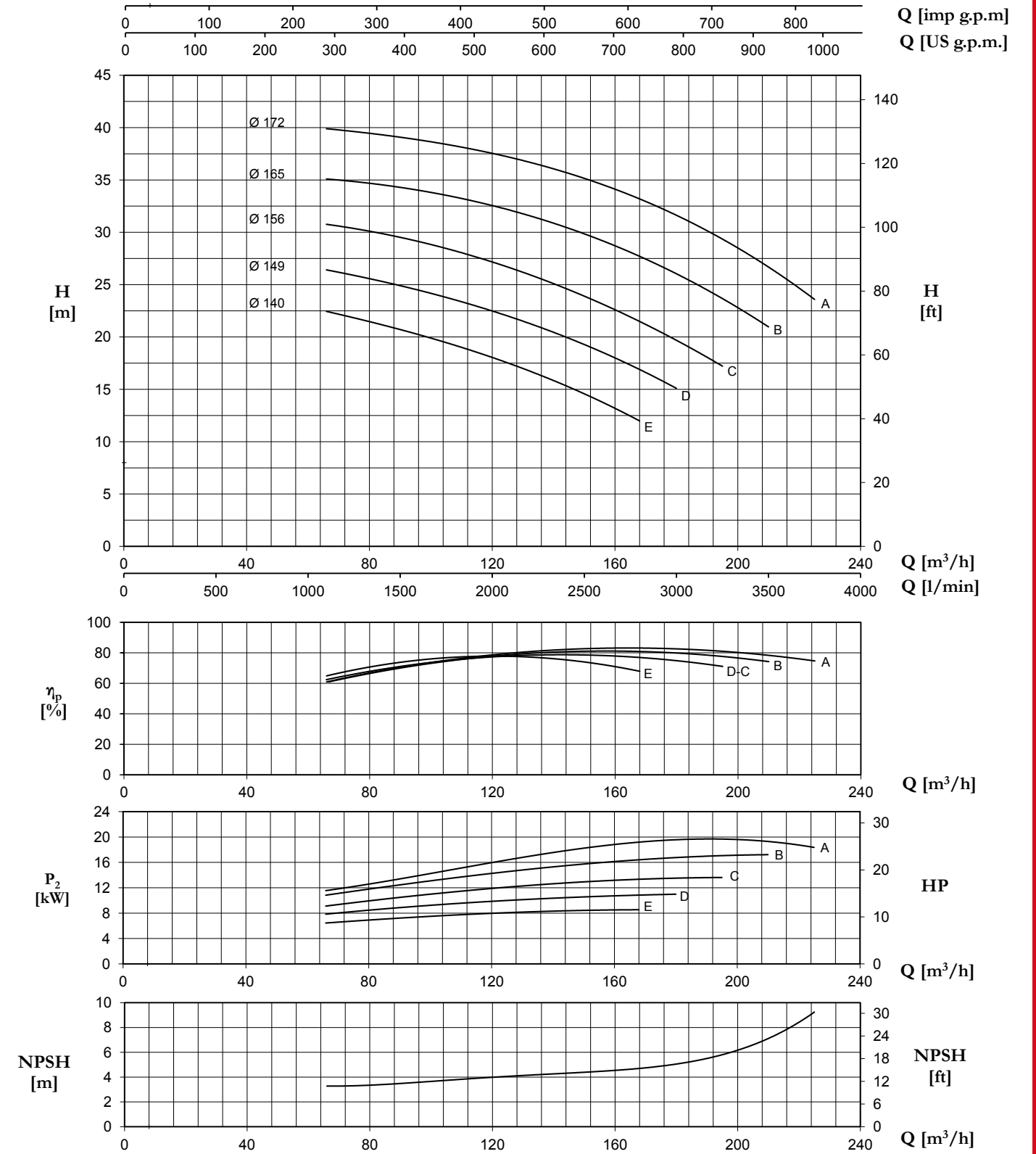

Tolerance: ISO 9906:2012 - Grade 3B

TYPE	Nominal Power (kW)	Motor Size	Q (m³/h - l/min)												
			0	78	96	108	120	144	168	180	195	210	225		
			0	1300	1600	1800	2000	2400	2800	3000	3250	3500	3750		
H (m) / pump input power (kW)															
80-160E	11	160M	21,4 3,6	21,6 6,8	20,2 7,3	19,2 7,6	18,0 8,0	15,4 8,4	12,0 8,4						
80-160D	11	160M	25,4 4,0	25,7 8,5	24,4 9,1	23,6 9,5	22,5 9,9	20,0 10,5	16,9 10,9	15,1 10,9					
80-160C	15	160M	29,7 5,2	30,3 9,7	29,2 10,7	28,1 11,1	27,1 11,7	24,7 12,7	21,5 13,3	19,7 13,5	17,2 13,5				
80-160B	18,5	160L	34,0 5,7	34,8 10,8	34,0 11,8	33,3 12,8	32,5 13,3	30,5 14,6	27,8 15,4	26,0 15,8	23,6 16,0	21,0 16,3			
80-160A	22	180M	38,8 7,3	39,6 13,3	38,9 14,6	38,2 15,6	37,5 16,5	35,7 18,0	33,2 19,3	31,6 19,8	29,4 20,3	26,8 21,0	23,5 20,1		

80-200

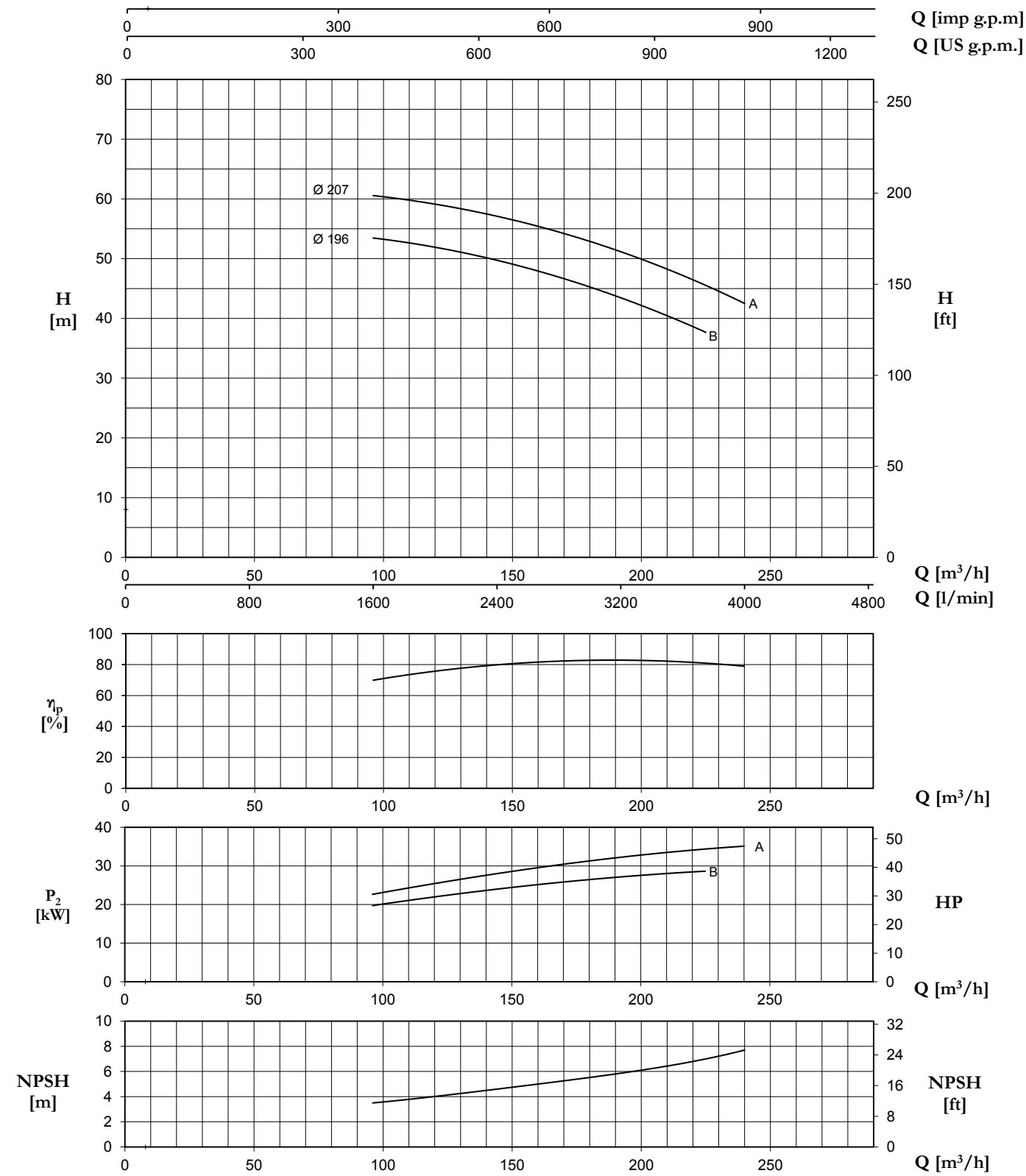

Tolerance: ISO 9906:2012 - Grade 3B

TYPE	Nominal Power (kW)	Motor Size	Q (m³/h - l/min)										
			0	96	120	132	156	168	180	210	225	240	
			0	1600	2000	2200	2600	2800	3000	3500	3750	4000	
			H (m) / pump input power (kW)										
80-200B	30	200L	50,1 9,20	53,5 19,70	51,8 21,99	50,9 23,00	48,5 24,85	46,9 25,69	45,2 26,46	40,4 28,05	37,7 28,62		
80-200A	37	200L	56,7 10,58	60,6 22,62	59,1 25,46	58,1 26,77	56,0 29,07	54,4 30,29	52,7 31,35	48,3 33,46	45,6 34,35	42,4 35,12	

80-250

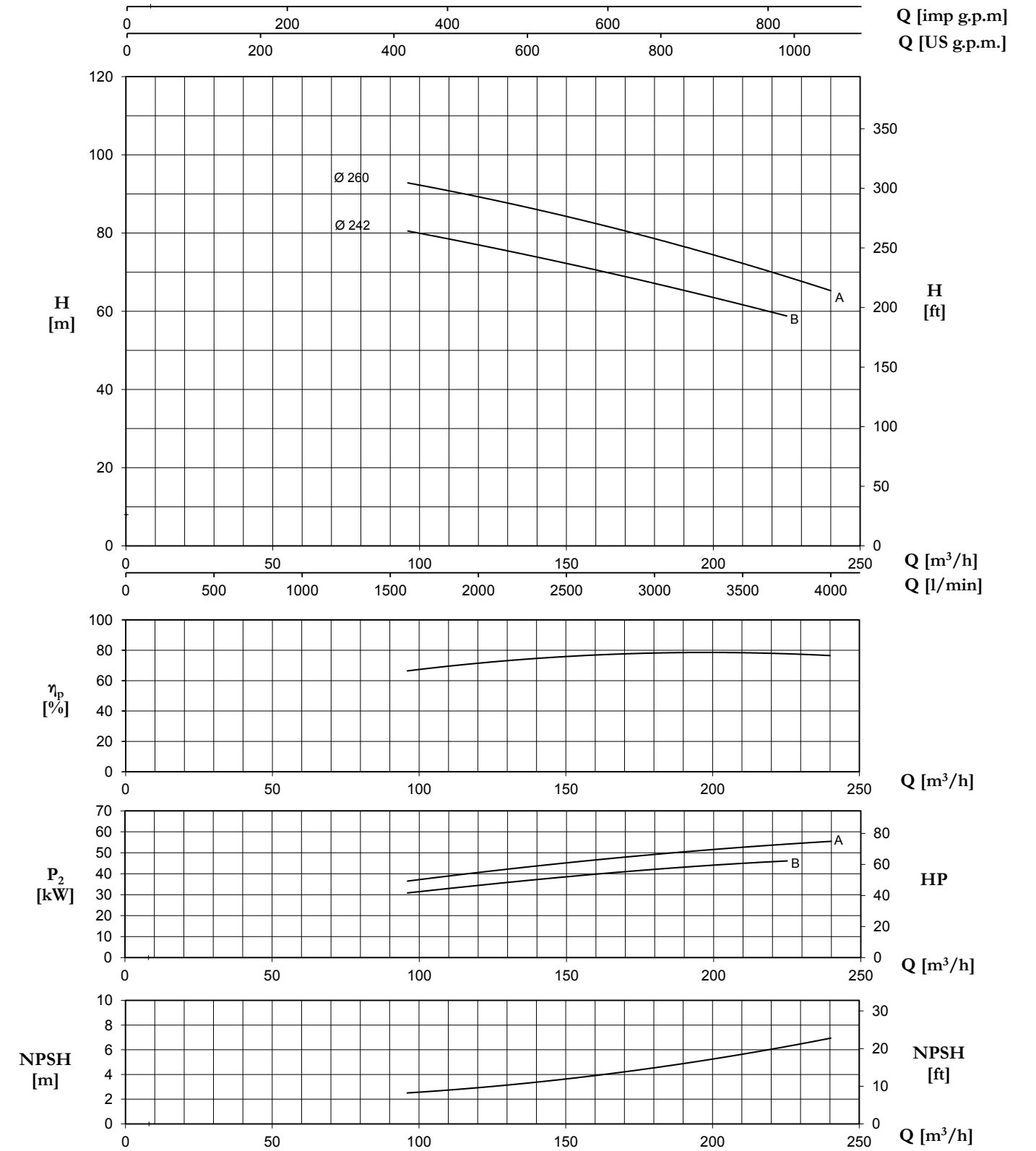

Tolerance: ISO 9906:2012 - Grade 3B

TYPE	Nominal Power (kW)	Motor Size	Q (m³/h - l/min)											
			0	96	108	120	144	168	180	195	210	225	240	
			0	1600	1800	2000	2400	2800	3000	3250	3500	3750	4000	
			H (m) / pump input power (kW)											
80-250 B	45	225M	77,2 14,01	80,0 30,93	79,0 32,60	77,5 34,34	73,1 37,86	69,0 40,78	67,0 42,10	64,5 43,60	61,8 44,94	58,8 46,15		
80-250 A	55	250M	90,0 16,74	92,8 36,56	91,1 38,57	89,3 40,54	85,4 44,31	80,7 47,81	78,5 49,29	75,7 50,92	72,4 52,59	68,8 54,18		

80-315

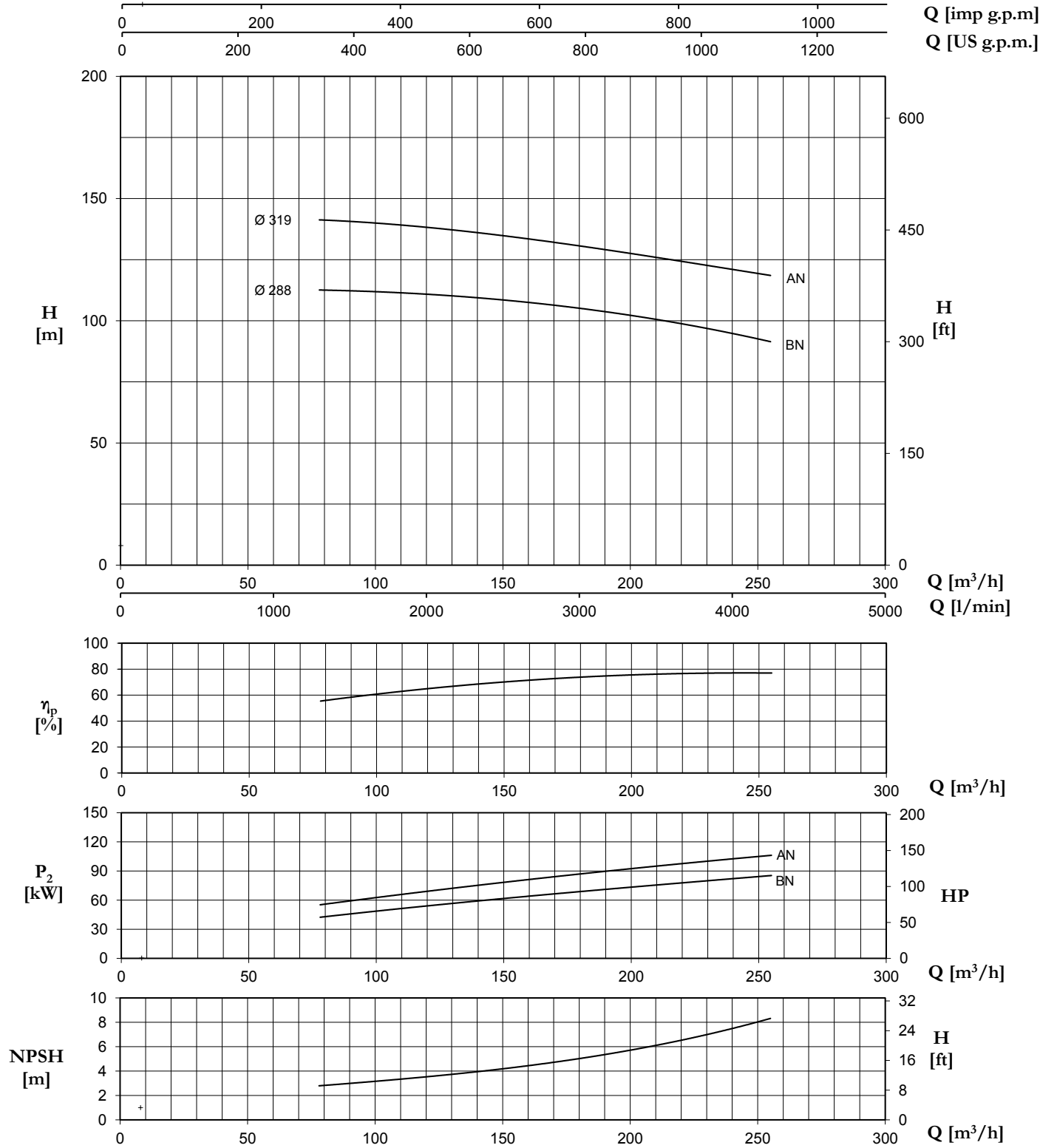

Tolerance: ISO 9906:2012 - Grade 3B

TYPE	Nominal Power (kW)	Motor Size	Q (m³/h - l/min)									
			0	78	96	120	144	168	195	225	255	
			0	1300	1600	2000	2400	2800	3250	3750	4250	
H (m) / pump input power (kW)												
80-315BN	90	280M	108,0	112,4	112,2	111,1	109,1	106,4	102,7	98,3	90,8	
			21,85	42,35	47,49	54,13	60,24	65,95	72,14	78,97	85,17	
80-315AN	110	315M	140,5	141,4	140,2	138,1	135,5	132,5	128,7	122,5	118,5	
			31,92	55,48	61,13	68,78	76,96	84,36	90,23	99,35	106,15	

100-200

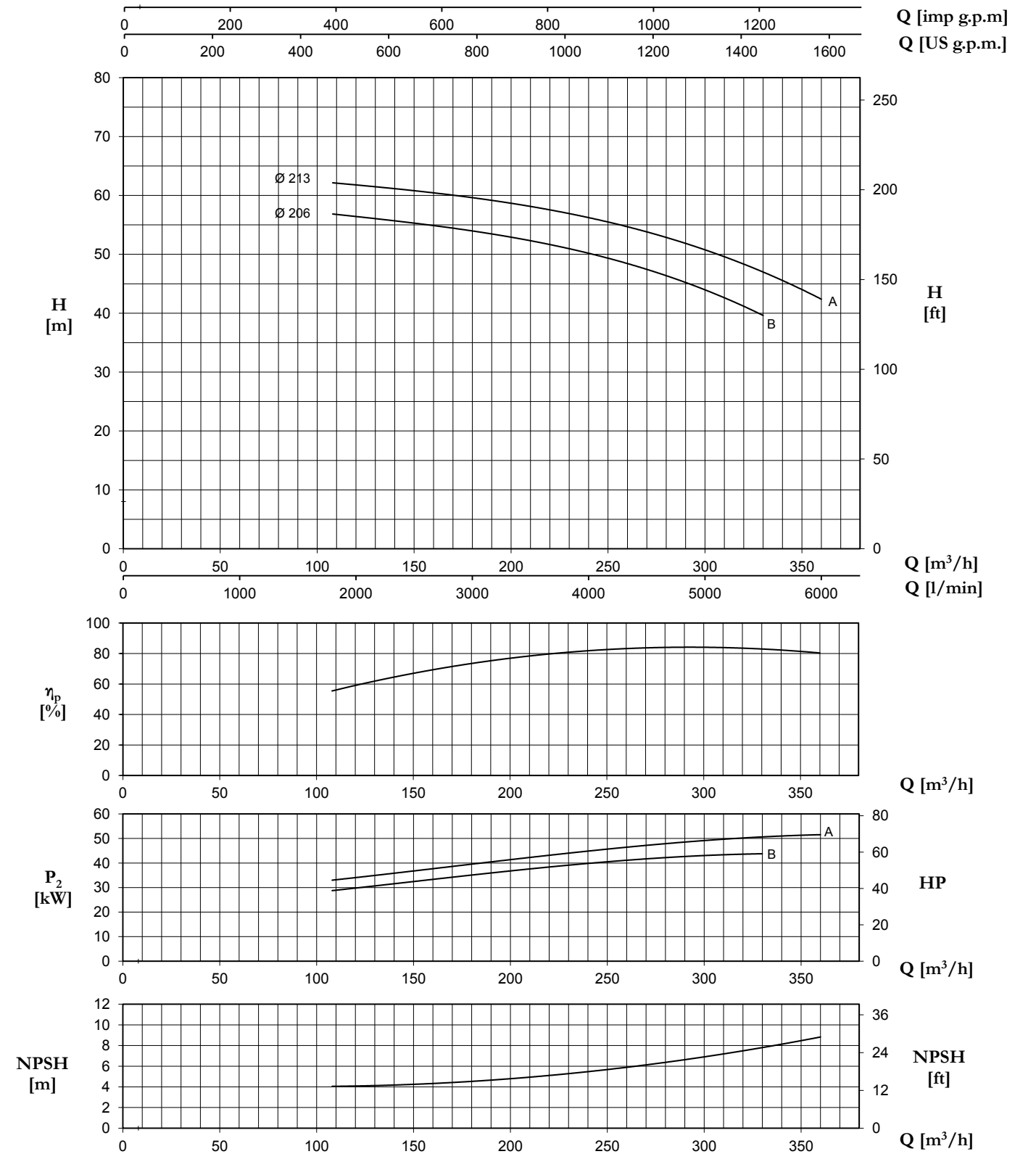

Tolerance: ISO 9906:2012 - Grade 3B

TYPE	Nominal Power (kW)	Motor Size	Q (m³/h - l/min)											
			0	108	144	168	210	225	240	270	300	330	360	
			0	1800	2400	2800	3500	3750	4000	4500	5000	5500	6000	
H (m) / pump input power (kW)														
100-200 B	45	225M	56,1	56,8	55,6	54,5	52,2	51,4	50,4	47,5	43,8	39,7		
			21,75	28,84	31,75	33,89	37,82	38,89	39,85	41,60	42,92	43,82		
100-200 A	55	250M	61,1	62,2	61,0	59,9	58,3	57,4	56,4	53,8	50,6	46,8		
			24,57	33,04	36,18	38,39	42,23	43,60	44,97	47,28	49,05	50,53		

CA/CAT - CAX EN 733 ~ 2900 r.p.m.

100-250

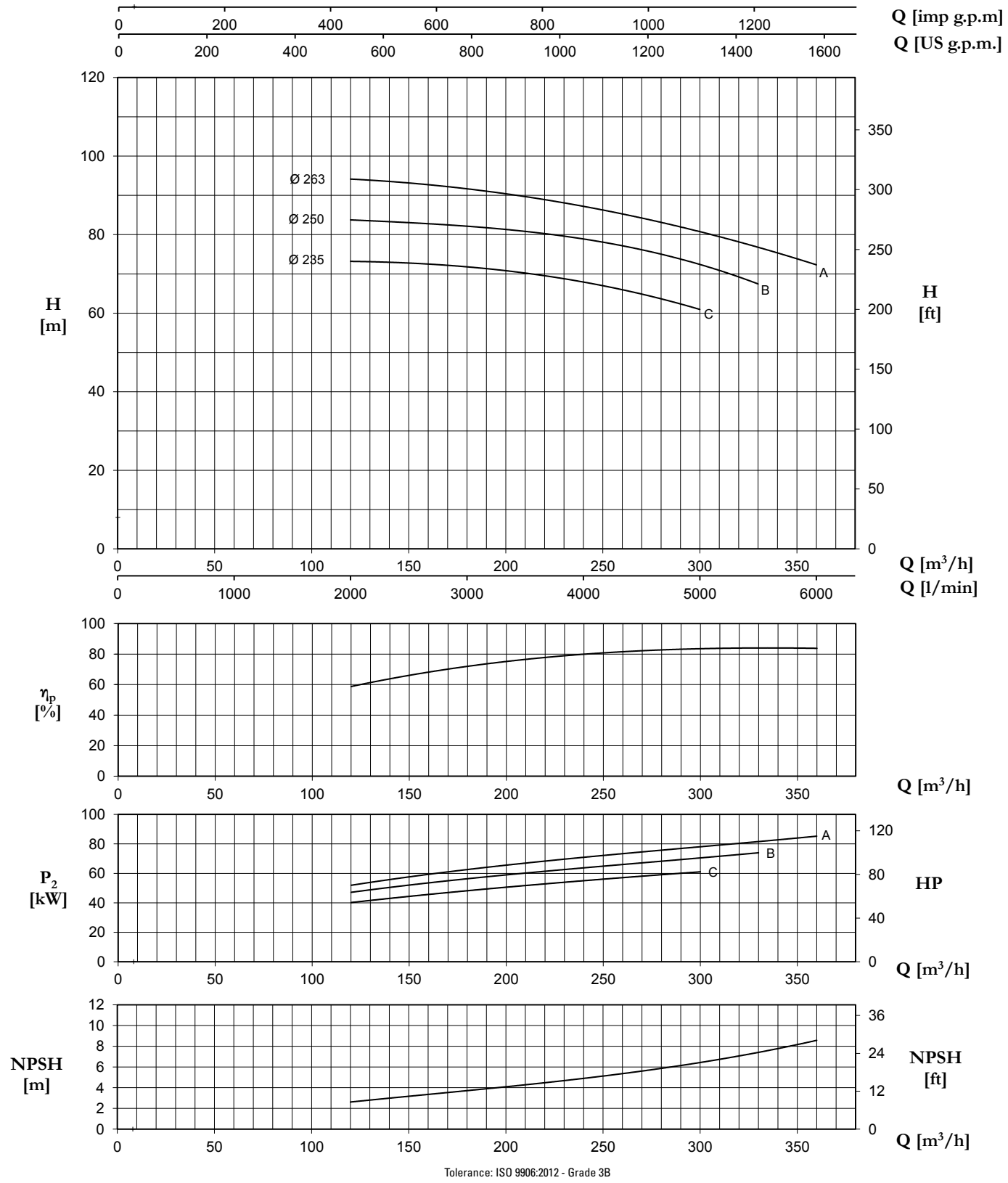

TYPE	Nominal Power (kW)	Motor Size	Q (m³/h - l/min)											
			0	120	144	168	210	225	255	270	300	330	360	
			0	2000	2400	2800	3500	3750	4250	4500	5000	5500	6000	
H (m) / pump input power (kW)														
100-250 C	55	250M	71,9	73,2	72,9	72,2	70,3	69,3	66,4	64,7	61,0			
	75	280S	24,75	40,12	43,70	46,77	51,65	53,38	56,66	58,19	60,99			
100-250 B	75	280S	83,6	83,7	83,2	82,5	80,8	80,0	77,9	76,4	72,0	67,6		
			29,69	47,10	51,01	54,76	60,26	61,86	65,17	66,93	70,91	73,78		
100-250 A	90	280M	93,5	93,9	93,4	92,4	89,9	88,8	85,7	84,0	80,4	75,8	73,2	
			32,71	51,99	56,31	60,60	66,97	68,84	72,81	74,73	78,17	81,33	85,53	

CA/CAT - CAX EN 733 ~ 2900 r.p.m.
4CA/4CAT - 4CAX EN 733 ~ 1450 r.p.m.

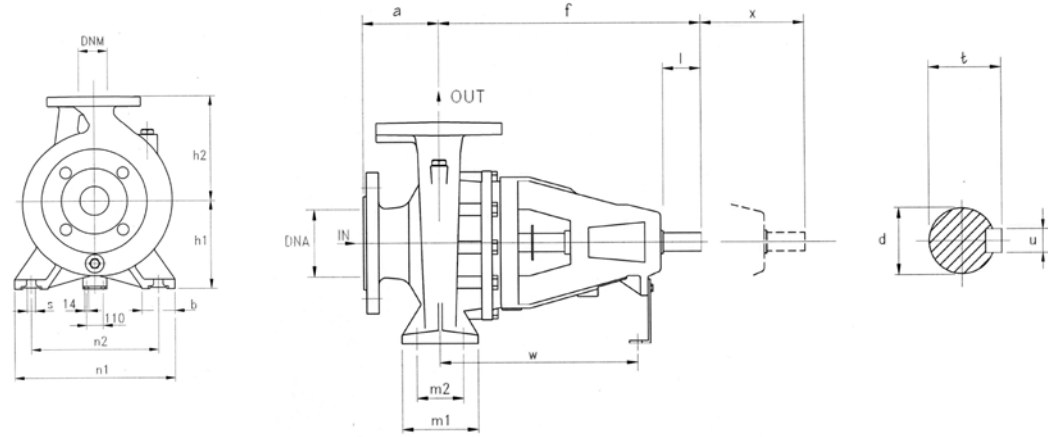

TYPE	DIMENSIONS (mm)																			I	L	M	Kg
	DNA	DNM	a	f	h1	h2	m1	m2	n1	n2	s	b	l	d	t	u	x	w					
32-160	50	32	80	360	132	160	100	70	240	190	14	50	50	24	27	8	100	260	535	320	445	38	
32-200			80	360	160	180	100	70	240	190	14	50	50	24	27	8	100	260	535	320	445	41	
32-250			100	360	180	225	125	95	320	250	14	65	65	24	27	8	100	260	680	405	545	49	
40-125	65	40	80	360	112	140	100	70	210	160	14	50	50	24	27	8	100	260	535	320	445	37	
40-160			80	360	132	160	100	70	240	190	14	50	50	24	27	8	100	260	535	320	445	40	
40-200			100	360	160	180	100	70	265	212	14	50	50	24	27	8	100	260	535	320	445	44	
40-250			100	360	180	225	125	95	320	250	14	65	50	24	27	8	100	260	680	405	545	49,5	
50-125	65	50	100	360	132	160	100	70	240	190	14	50	50	24	27	8	100	260	535	320	445	39,5	
50-160			100	360	160	180	100	70	265	212	14	50	50	24	27	8	100	260	535	320	445	44	
50-200			100	360	160	200	100	70	265	212	14	50	50	24	27	8	100	260	535	320	445	47	
50-250			100	360	180	225	125	95	320	250	14	65	50	24	27	8	100	260	680	405	545	53	
50-315			80	125	470	225	280	125	95	345	280	14	65	80	32	35,3	10	100	340	655	465	620	94,5
65-125	80	65	100	360	160	180	125	95	280	212	14	65	65	24	27	8	100	260	535	320	445	44,5	
65-160			100	360	160	200	125	95	280	212	14	65	65	24	27	8	100	260	535	320	445	49	
65-200			100	360	180	225	125	95	320	250	14	65	65	24	27	8	140	260	680	405	545	54	
65-250			100	470	200	250	160	120	360	280	19	80	80	32	35	10	140	340	680	405	545	76,5	
65-315			125	470	225	280	160	120	400	315	19	80	80	32	35	10	140	340	655	465	620	96	
80-160			100	80	125	360	180	225	125	95	320	250	14	65	50	24	27	8	140	260	680	405	545
80-200	125	470			180	250	125	95	345	280	14	65	80	32	35	10	140	340	680	405	545	74	
80-250	125	470			200	280	160	120	400	315	18	80	80	32	35,3	10	140	340	655	465	585	91	
80-315	125	470			250	315	160	120	400	315	18	80	80	32	35,3	10	140	340	655	465	620	106	
100-200	125	470			200	280	160	120	360	286	18	80	80	32	35,3	10	140	340	655	465	620	95	
100-250	125	100	140	470	225	280	160	120	400	315	18	80	80	32	35,3	10	140	340	655	465	620	103	
100-315			140	470	250	315	160	120	400	315	18	80	80	32	35,3	10	140	340	655	465	620	122	
100-400			140	530	280	355	200	150	500	400	22	100	110	42	45,3	12	140	370	720	775	855	183,5	
125-250	150	125	160	530	315	450	200	150	400	315	22	100	110	32	45,3	12	140	370	655	465	620	132	
125-315			140	530	280	355	200	150	500	400	22	100	110	42	45,3	12	140	370	720	775	855	176	
125-400			140	530	315	400	200	150	500	400	22	100	110	42	45,3	12	140	370	720	775	855	198	
150-315	200	150	160	530	280	400	200	150	550	450	22	100	110	42	45,3	12	140	370	655	465	620	191	
150-400	200	150	160	530	315	450	200	150	550	450	22	100	110	42	45,3	12	140	370	720	775	855	218,5	
200-315	250	200	180	706	355	450	250	190	634	500	28	134	110	55	58,3	16	208	523	800	1200	1150	345	
200-400			180	706	355	500	250	190	634	500	28	134	110	55	58,3	16	214	523	800	1200	1150	346	
250-315	300	250	225	711	400	500	250	200	694	560	28	134	110	55	58,3	16	214	528	800	1200			
250-400			225	706	400	550	250	200	694	560	28	134	110	55	58,3	16	220	523	800	1200			

flanges

DN	D	K	holes	
			n°	Ø
			32	140
40	150	110	4	18
50	165	125	4	18
65	185	145	4	18
80	200	160	8	18
100	220	180	8	18
125	250	210	8	18
150	285	240	8	23
200	340	295	8	23
250	395	350	12	23
300	445	400	12	23

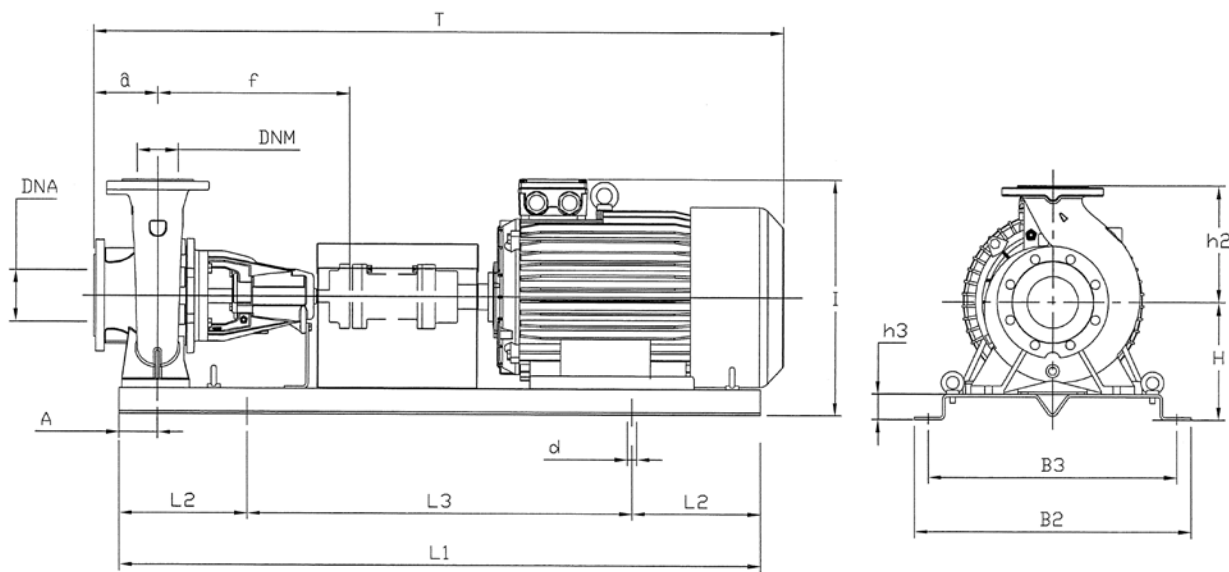

Table with columns: TYPE, kW, Motor Size, DIMENSIONS (mm) (DNA, DNM, a, f, H, h2, h3, L1, L2, L3, B2, B3, A, d, T, I), and weight (Kg). Rows include models 32-160C to 40-250AM.

Table with columns: TYPE, kW, Motor Size, DIMENSIONS (mm) (DNA, DNM, a, f, H, h2, h3, L1, L2, L3, B2, B3, A, d, T, I), and weight (Kg). Rows include models 50-125B to 100-250A.