

MA/MAT EN 733 ~ 2900 r.p.m.

MAX EN 733 ~ 2900 r.p.m.

4MA/4MAT EN 733 ~ 1450 r.p.m.

4MAX EN 733 ~ 1450 r.p.m.



MA/MAT
4MA/4MAT



MAX
4MAX

CARATTERISTICHE COSTRUTTIVE / CONSTRUCTION FEATURES CARACTERÍSTICAS CONSTRUCTIVAS / CARACTÉRISTIQUES D'EXÉCUTION

Corpo pompa Pump body Cuerpo bomba Corps de pompe	ghisa (MA/MAT) - acciaio inossidabile AISI 316 (MAX) cast iron (MA/MAT) - stainless steel AISI 316 (MAX) fundición (MA/MAT) - acero inoxidable AISI 316 (MAX) fonte (MA/MAT) - acier inox AISI 316 (MAX)
Supporto motore Motor bracket Soporte motor Support moteur	ghisa cast iron fundición fonte
Girante Impeller Rodete Turbine	ghisa, bronzo, acciaio (MA/MAT) - acciaio (MAX) cast iron, bronze, steel (MA/MAT) - steel (MAX) fundición, bronce, acero (MA/MAT) - acero (MAX) fonte, bronze, acier (MA/MAT) - acier (MAX)
Tenuta Seal Sello	meccanica ceramica-grafite (MA/MAX) o a baderna cotone impregnato grafite (MAT) mechanical ceramic-graphite (MA/MAX) or gland packing graphite impregnated (MAT) mecánico cerámica-grafito (MA/MAX) or a trenza algodón impregnado de grafito (MAT)
Garniture	mécanique céramique-graphite (MA/MAX) ou à baderne coton imprégné graphite (MAT)
Sporgenza albero pompa Pump shaft end Bomba eje Pompe arbre	acciaio AISI 316 stainless steel AISI 316 acero AISI 316 acier AISI 316
Temperatura del liquido Liquid temperature Temperatura del liquido Température du liquide	-10 ÷ +90 °C
Pressione di esercizio Operating pressure Presión de trabajo Pression de fonctionnement	max 10 bar max 14 bar (... -315 ~ 2900 r.p.m.)
MOTORE / MOTOR / MOTOR / MOTEUR	
Disponibile con motore classe di efficienza IE3 o standard Available with IE3 efficiency class motor or standard Disponibile con motor class IE3 o estandar Disponible avec moteur classe IE3 ou standard	

Pompe centrifughe ad asse libero costruite secondo le norme EN 733; trovano vasto utilizzo nell'alimentazione idrica, negli impianti di pressurizzazione e antincendio; come standard vengono fornite di controflangia.

Bare shaft centrifugal pumps constructed to EN 733 standards; widely used in water supplies, pressurisation and fire-fighting systems, standard supply with counter-flange.

Bombas centrífugas de eje libre fabricadas según las normas EN 733; se utilizan en gran parte en la alimentación hídrica, en las instalaciones de presurización y antiincendio; según el estándar se suministran con contrabrida.

Pompes centrifuges à axe libre, fabriquées conformément aux normes EN 733. Elles trouvent une ample utilisation dans l'approvisionnement d'eau, dans les installations de pressurisation et anti-incendie; fournies de série avec contre-bride.

~ 2900 r.p.m. MA/MAT - MAX EN 733
~ 1450 r.p.m. 4MA/4MAT - 4MAX EN 733

VARIANTI COSTRUTTIVE / VERSIONS VARIABLES COSTRUTTIVAS / VARIANTES DE CONSTRUCTIONS

MA

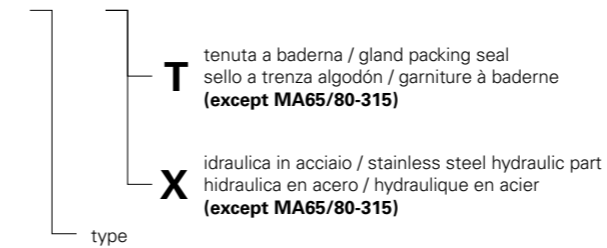

4MA

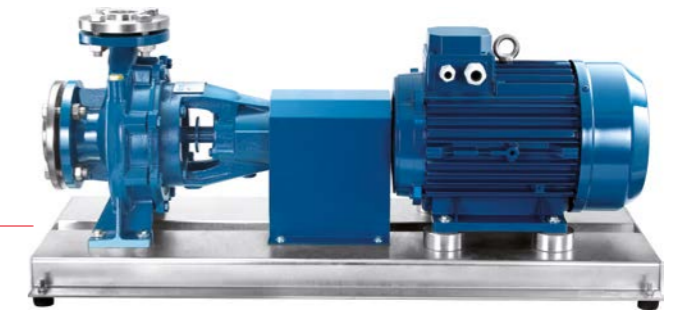
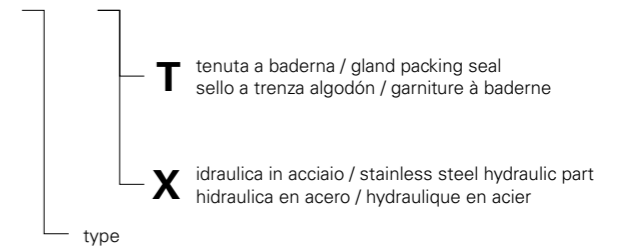

MA/MAT
4MA/4MAT

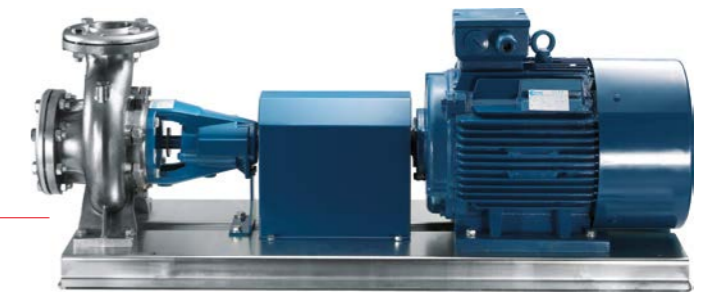

MAX
4MAX



MA/MAX
4MA/4MAX
tenuta meccanica
mechanical seal
sello mecánico
garniture mécanique



MAT
4MAT
tenuta a baderna
gland packing seal
sello a trenza algodón
garniture à baderne

4MA/4MAT - 4MAX ~ 1450 r.p.m.

Macchine a completamento gamma, non contemplate nella normativa EN 733.

Machines complementing the existing range, not envisaged in the EN 733 standard.

Máquinas para completar la gama, no contempladas en la norma EN 733.

*Machines venant compléter la gamme, non couvertes par la norme EN 733.***~ 1450 r.p.m. 4MA/4MAT - 4MAX**

Macchine a completamento gamma, non contemplate nella normativa EN 733.

Machines complementing the existing range, not envisaged in the EN 733 standard.

Máquinas para completar la gama, no contempladas en la norma EN 733.

Machines venant compléter la gamme, non couvertes par la norme EN 733.

TYPE	Nominal Power (kW)	Motor Size	Q (m³/h - l/min)							Q (m³/h - l/min)								
			0	200	250	400	600	800		850	900	1100	1170	1200	1300	1400	1500	1600
			0	3333	4167	6667	10000	13333		14167	15000	18333	19500	20000	21667	23333	25000	26667
			H (m)							H (m)								
			pump input power (kW)							pump input power (kW)								
200-315D	37	225S	21,2 18,00	21,7 24,31	21,8 26,11	21,2 31,21	18,3 36,07	12,5 37,00										
200-315C	45	225M	26,6 21,54	26,6 29,42	26,4 31,44	25,9 37,61	23,1 43,07	16,9 45,42		14,6 45,55								
200-315B	55	250M	33,4 25,04	33,4 36,30	33,2 38,91	32,2 46,32	28,6 52,72	21,7 55,67		19,4 55,62	16,7 55,25							
200-315A	75	280S	36,3 27,90	35,9 39,49	35,8 42,13	35,0 50,07	31,8 58,82	24,9 62,36		22,5 62,45	19,8 62,15							
200-400C	90	280M	43,0 31,27	44,1 45,90	44,1 50,14	43,6 62,49	39,9 77,58	31,5 89,60										
200-400B	110	315S	49,5 40,00	50,8 54,29	51,0 58,92	50,6 73,89	47,2 91,32	39,5 105,65		36,6 108,43								
200-400A	132	315M	57,2 49,00	58,5 65,01	58,6 70,26	58,2 87,26	55,2 107,05	48,2 124,54		45,6 128,46	44,0 132,15							
250-315C	55 75	280M 280S	26,1 28,00		25,5 37,82	25,3 44,23	24,1 51,71	22,3 57,65		21,7 58,82	21,0 59,57	16,8 59,89						
250-315B	75	280S	33,2 43,46		33,0 54,77	32,7 61,20	31,8 68,72	29,6 74,57		28,6 75,26	27,5 75,64	21,7 74,47	19,0 73,35					
250-315A	90	280M	35,8 46,41		35,0 57,61	34,4 64,50	33,3 73,28	31,3 78,44		30,4 79,01	29,3 79,32	23,0 78,27	20,7 77,03	20,0 76,36				
250-400D	110 132	315S 315M	38,3 48,00		39,9 61,74	39,9 71,25	39,0 84,15	36,9 95,73		36,1 98,36	35,2 100,80	30,6 108,97	28,6 111,27	27,7 112,17	24,3 114,78			
250-400C	132 160	315M 315L	44,0 53,83		45,8 71,89	45,9 83,20	44,9 98,11	42,7 112,06		42,0 115,25	41,2 118,20	37,2 128,07	35,4 130,85	34,5 131,93	31,3 135,08	27,4 137,50		
250-400B	160 200	315L 315L	50,0 64,57		51,7 84,18	51,8 97,49	51,0 115,36	49,0 131,10		48,4 134,76	47,6 138,27	43,9 151,48	42,3 155,58	41,5 157,12	38,5 161,60	34,8 164,88	30,3 167,09	
250-400A	200	315L	55,7 70,94		57,4 91,89	57,5 106,81	56,5 127,19	54,5 145,00		53,8 149,18	53,0 153,24	49,4 168,92	47,9 173,94	47,1 175,86	44,3 181,62	40,8 186,11	36,6 189,07	31,7 190,57

4MA/4MAT - 4MAX EN 733 ~ 1450 r.p.m.

32-160

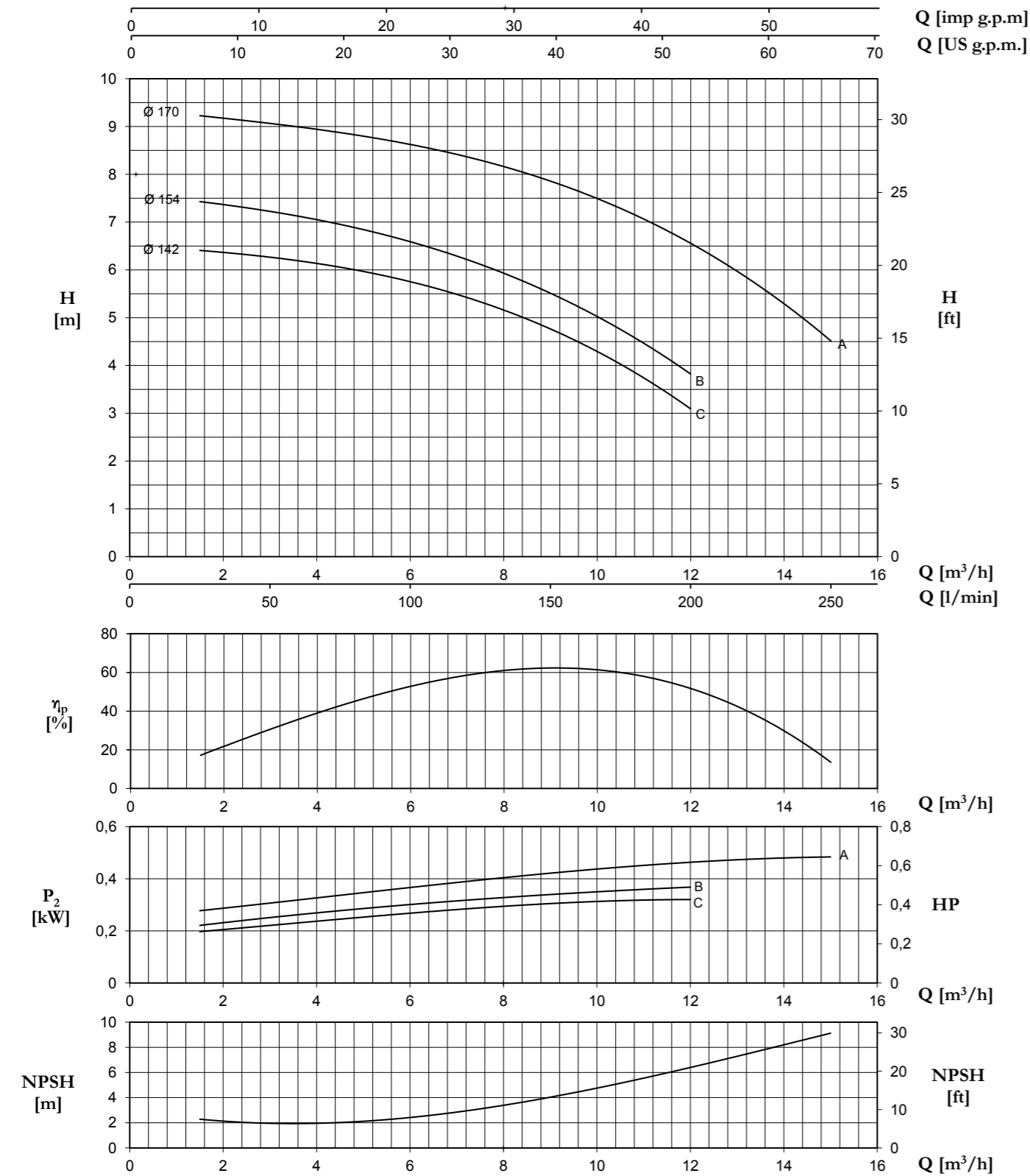

Tolerance: ISO 9906:2012 - Grade 3B

TYPE	Nominal Power (kW)	Motor Size	Q (m³/h - l/min)											
			0	1,5	3	4,5	6	7,5	9	10,5	12	15		
			0	25	50	75	100	125	150	175	200	250		
H (m) / pump input power (kW)														
32-160C	0,37	71M	6,4	6,4	6,3	6,0	5,8	5,3	4,8	4,0	3,1			
			0,17	0,20	0,22	0,24	0,27	0,29	0,31	0,31	0,32			
32-160B	0,37	71M	7,4	7,4	7,3	6,9	6,6	6,1	5,5	4,8	3,8			
			0,19	0,22	0,25	0,28	0,30	0,32	0,34	0,35	0,37			
32-160A	0,55	80M	9,2	9,2	9,1	8,9	8,6	8,3	7,8	7,3	6,6	4,5		
			0,24	0,28	0,31	0,33	0,37	0,39	0,42	0,44	0,46	0,48		

~ 1450 r.p.m. 4MA/4MAT - 4MAX EN 733

32-200

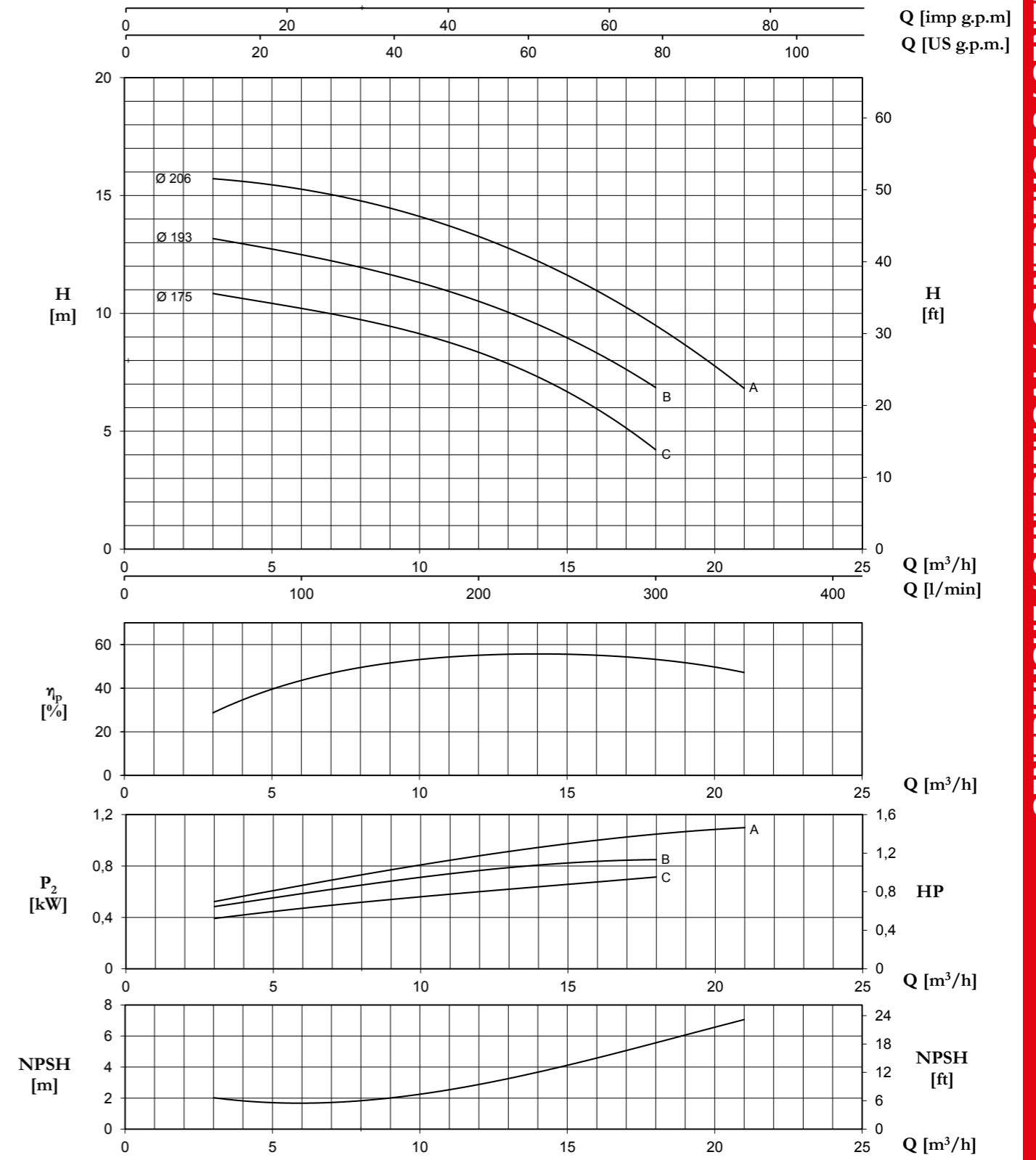

Tolerance: ISO 9906:2012 - Grade 3B

TYPE	Nominal Power (kW)	Motor Size	Q (m³/h - l/min)											
			0	3	4,5	6	7,5	9	10,5	12	15	18	21	
			0	50	75	100	125	150	175	200	250	300	350	
H (m) / pump input power (kW)														
32-200C	0,75	80M	11,0	10,8	10,6	10,2	9,9	9,4	8,9	8,4	6,7	4,2		
			0,26	0,39	0,43	0,47	0,51	0,54	0,57	0,59	0,66	0,71		
32-200B	1,1	90S	13,4	13,1	12,9	12,6	12,1	11,6	11,0	10,5	9,1	6,8		
			0,40	0,49	0,53	0,59	0,63	0,69	0,73	0,77	0,82	0,85		
32-200A	1,1	90S	15,9	15,7	15,5	15,3	15,0	14,5	13,8	13,2	11,7	9,5	6,8	
			0,44	0,53	0,57	0,66	0,71	0,77	0,82	0,88	0,98	1,04	1,10	

4MA/4MAT - 4MAX EN 733 ~ 1450 r.p.m.

32-250

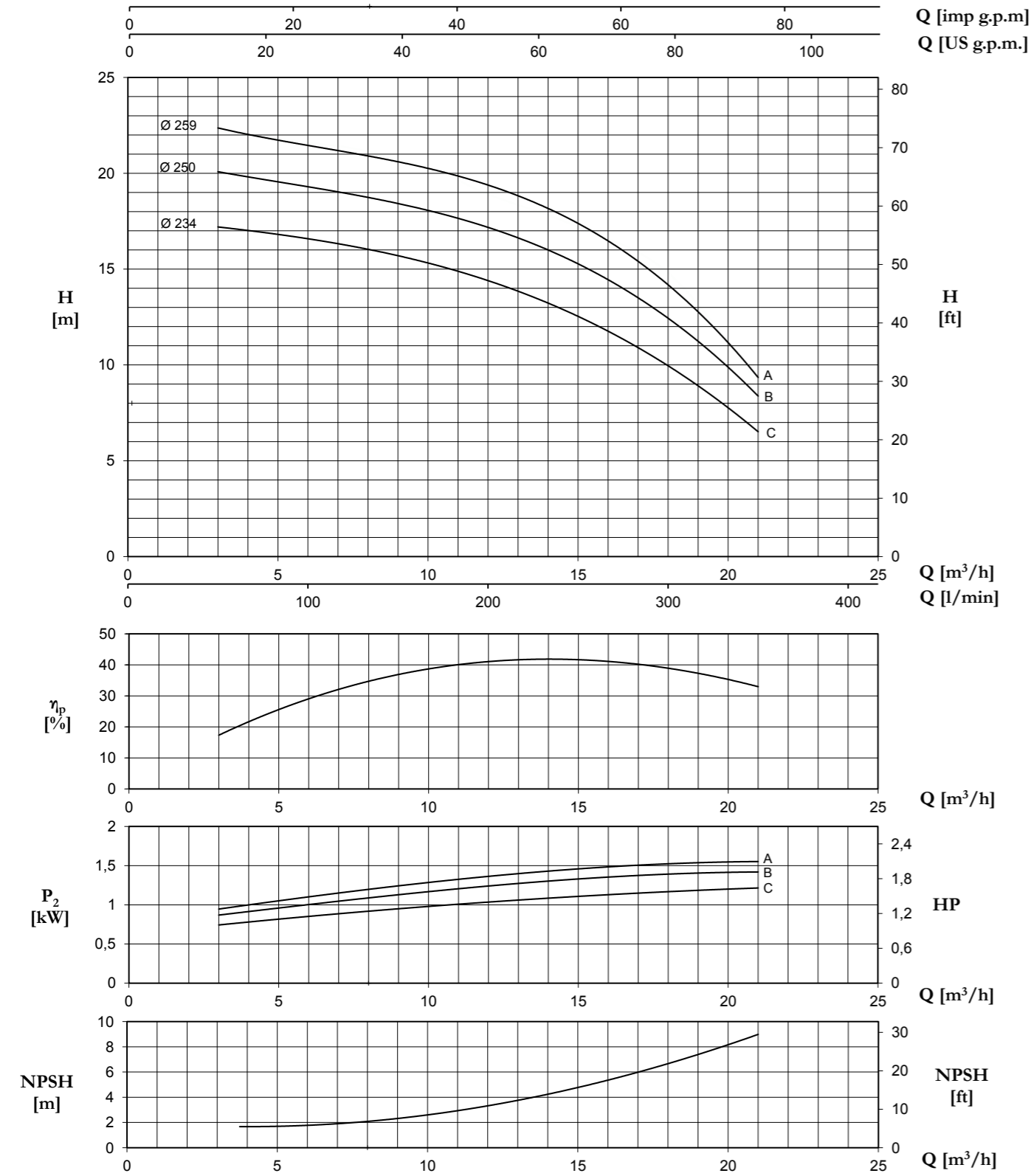

Tolerance: ISO 9906:2012 - Grade 3B

TYPE	Nominal Power (kW)	Motor Size	Q (m³/h - l/min)																					
			0	3	4,5	6	7,5	9	10,5	12	15	18	21											
			0	50	75	100	125	150	175	200	250	300	350											
H (m) / pump input power (kW)																								
32-250C	1,5	90L	17,5	17,2	16,9	16,6	16,2	15,7	15,1	14,4	12,5	10,0	6,5	0,55	0,75	0,79	0,85	0,90	0,95	1,00	1,04	1,09	1,18	1,21
			20,3	20,0	19,7	19,4	19,0	18,4	17,8	17,0	15,3	12,6	8,3	0,75	0,87	0,93	1,00	1,06	1,14	1,19	1,24	1,33	1,39	1,42
32-250B	1,5	90L	22,6	22,2	21,9	21,6	21,3	20,7	20,0	18,9	17,2	14,8	9,1	0,80	0,95	1,03	1,10	1,18	1,24	1,30	1,36	1,46	1,52	1,55

~ 1450 r.p.m. 4MA/4MAT - 4MAX EN 733

40-125

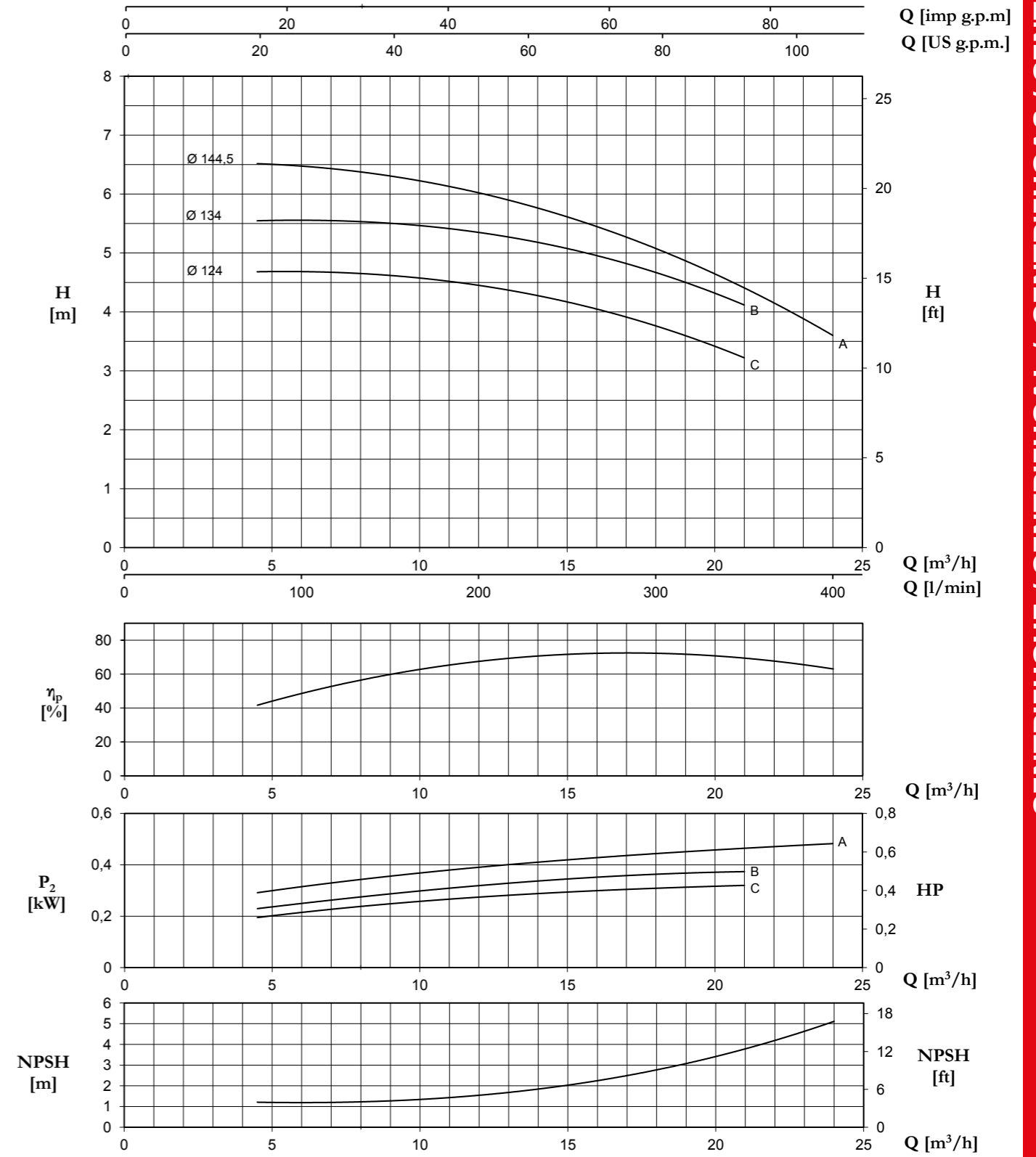

Tolerance: ISO 9906:2012 - Grade 3B

TYPE	Nominal Power (kW)	Motor Size	Q (m³/h - l/min)																					
			0	4,5	6	7,5	9	10,5	12	15	18	21	24											
			0	75	100	125	150	175	200	250	300	350	400											
H (m) / pump input power (kW)																								
40-125C	0,37	71M	4,6	4,8	4,7	4,6	4,5	4,4	4,2	3,8	3,2	2,4	0,17	0,20	0,21	0,23	0,25	0,26	0,28	0,29	0,31	0,32	0,32	
			5,5	5,6	5,6	5,5	5,4	5,3	5,1	4,7	4,1	3,4	0,19	0,23	0,25	0,27	0,29	0,30	0,32	0,35	0,36	0,37	0,37	
40-125B	0,37	71M	6,4	6,5	6,5	6,4	6,3	6,2	6,0	5,6	5,1	4,4	3,6	0,24	0,29	0,31	0,33	0,35	0,37	0,39	0,42	0,44	0,46	0,48

4MA/4MAT - 4MAX EN 733 ~ 1450 r.p.m.

40-160

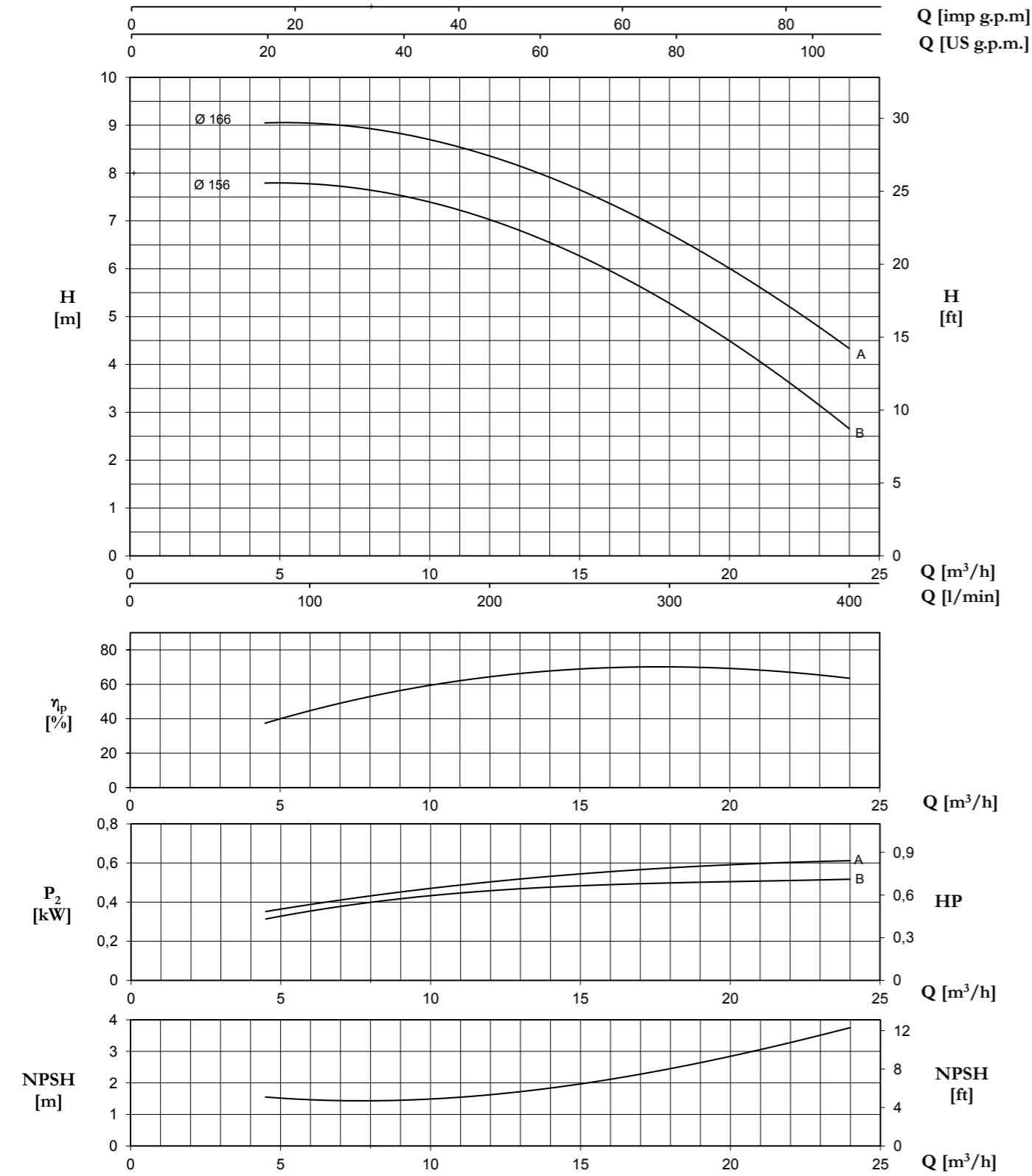

Tolerance: ISO 9906:2012 - Grade 3B

TYPE	Nominal Power (kW)	Motor Size	Q (m³/h - l/min)											
			0	4,5	6	7,5	9	10,5	12	15	18	21	24	
			0	75	100	125	150	175	200	250	300	350	400	
			H (m) / pump input power (kW)											
40-160B	0,55	80M	7,7 0,22	7,8 0,31	7,9 0,36	7,7 0,39	7,5 0,42	7,3 0,44	7,1 0,46	6,4 0,48	5,2 0,50	4,0 0,51	2,7 0,52	
40-160A	0,75	80M	8,9 0,23	9,0 0,35	9,1 0,39	9,0 0,42	8,8 0,46	8,6 0,48	8,4 0,50	7,6 0,54	6,7 0,58	5,7 0,60	4,3 0,61	

~ 1450 r.p.m. 4MA/4MAT - 4MAX EN 733

40-200

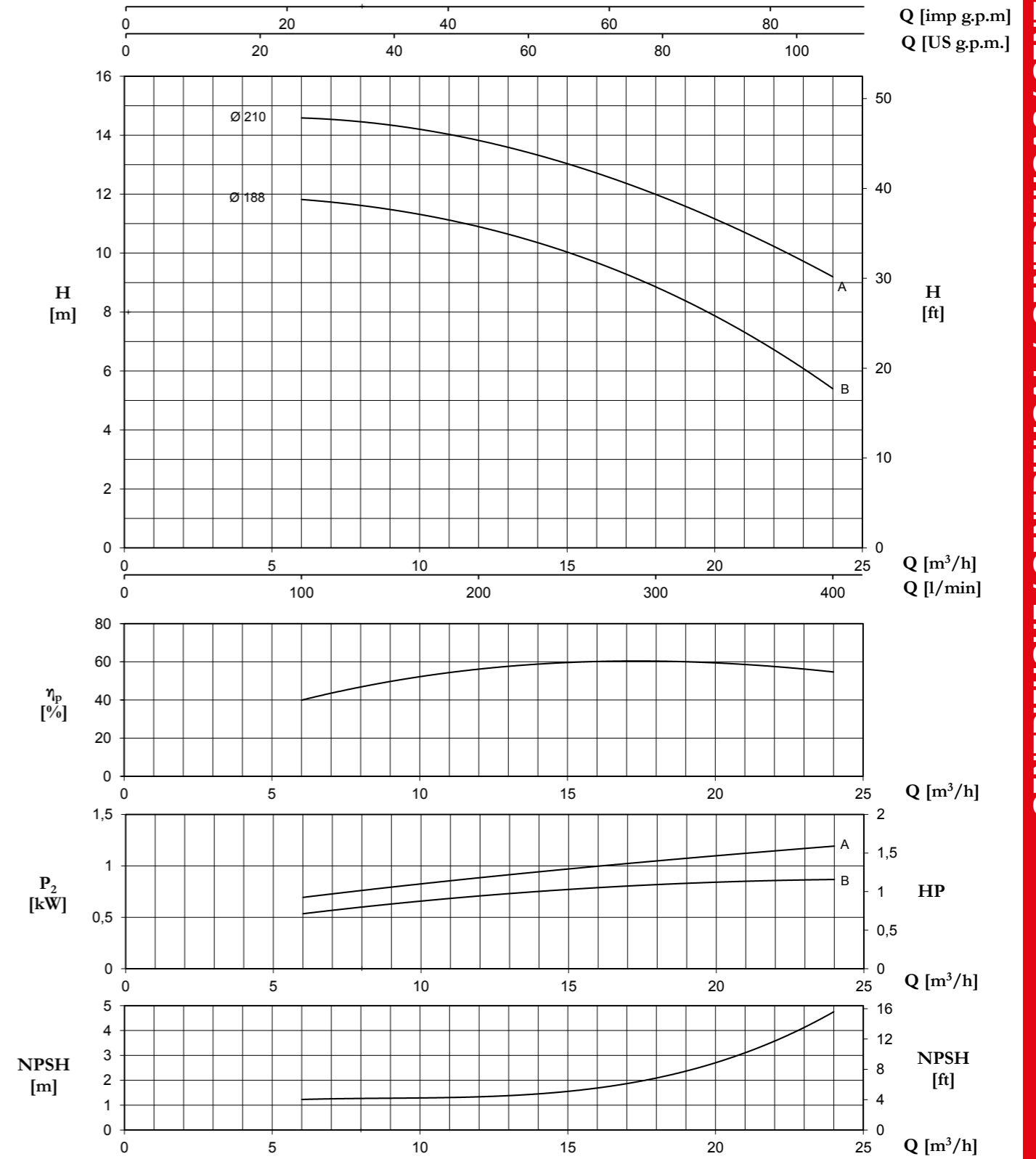

Tolerance: ISO 9906:2012 - Grade 3B

TYPE	Nominal Power (kW)	Motor Size	Q (m³/h - l/min)											
			0	6	7,5	9	10,5	12	15	18	21	24		
			0	100	125	150	175	200	250	300	350	400		
			H (m) / pump input power (kW)											
40-200B	1,1	90S	11,7 0,38	11,8 0,54	11,7 0,58	11,5 0,62	11,2 0,67	10,9 0,71	10,0 0,78	8,9 0,81	7,3 0,85	5,4 0,87		
40-200A	1,1 1,5	90S 90L	14,5 0,40	14,6 0,68	14,5 0,77	14,3 0,79	14,1 0,84	13,9 0,88	13,0 0,97	12,0 1,05	10,7 1,13	9,2 1,19		

40-250

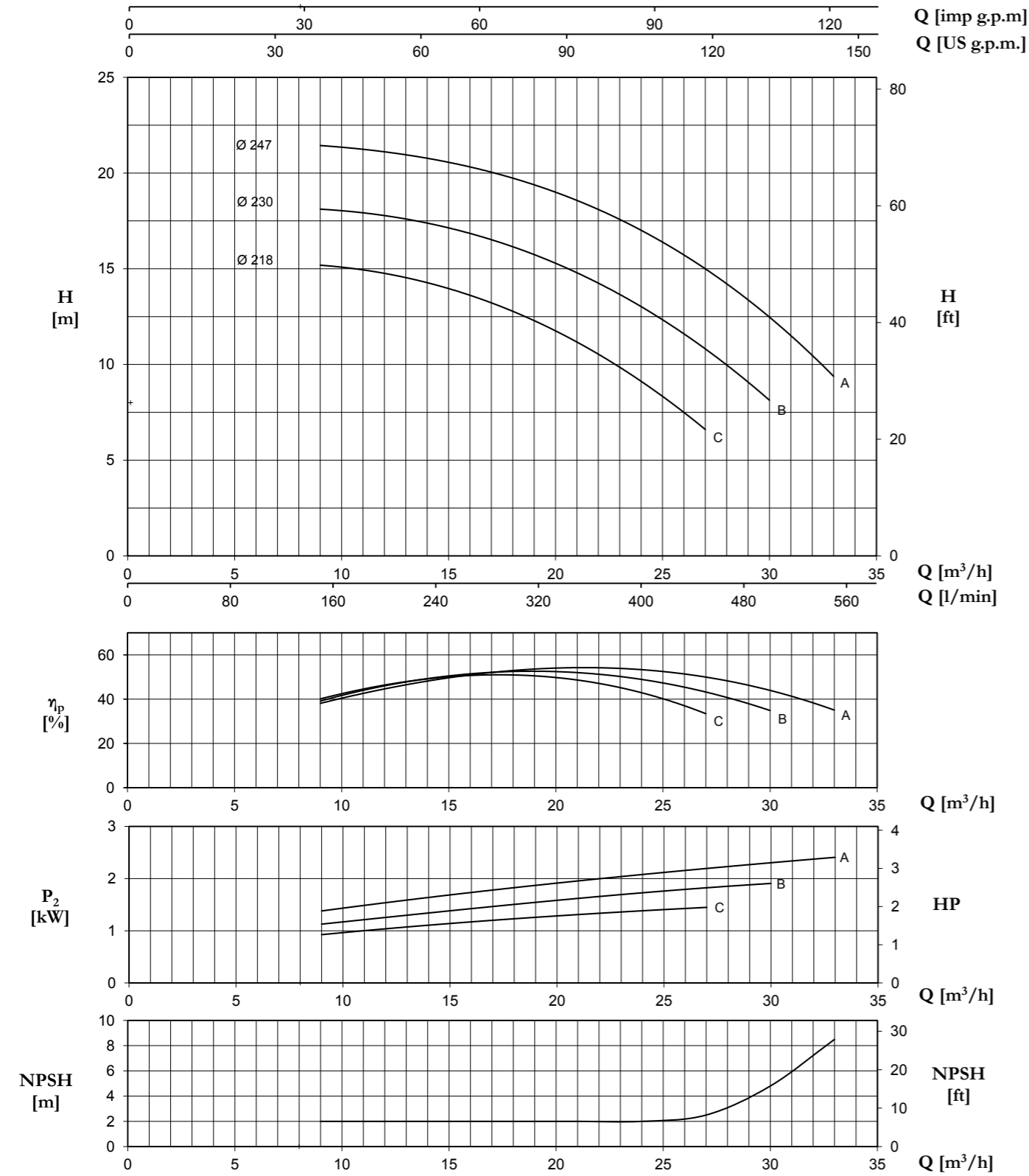

Tolerance: ISO 9906:2012 - Grade 3B

TYPE	Nominal Power (kW)	Motor Size	Q (m³/h - l/min)																
			0	9	10,5	12	15	18	21	24	27	30	33						
			0	150	175	200	250	300	350	400	450	500	550						
			H (m) / pump input power (kW)																
40-250C	1,1 1,5	90S 90L	15,7 0,61	15,2 0,93	15,0 0,98	14,7 1,04	14,0 1,14	12,8 1,22	11,1 1,32	9,1 1,38	6,6 1,45								
40-250B	2,2	100L	18,3 0,73	18,2 1,13	17,9 1,19	17,7 1,24	17,1 1,39	16,2 1,51	14,9 1,62	12,9 1,73	10,7 1,82	8,2 1,91							
40-250A	2,2 3	100L 100L	21,6 0,93	21,5 1,38	21,3 1,46	21,1 1,54	20,5 1,68	19,7 1,82	18,6 1,96	17,1 2,08	15,0 2,19	12,3 2,30	9,5 2,41						

50-125

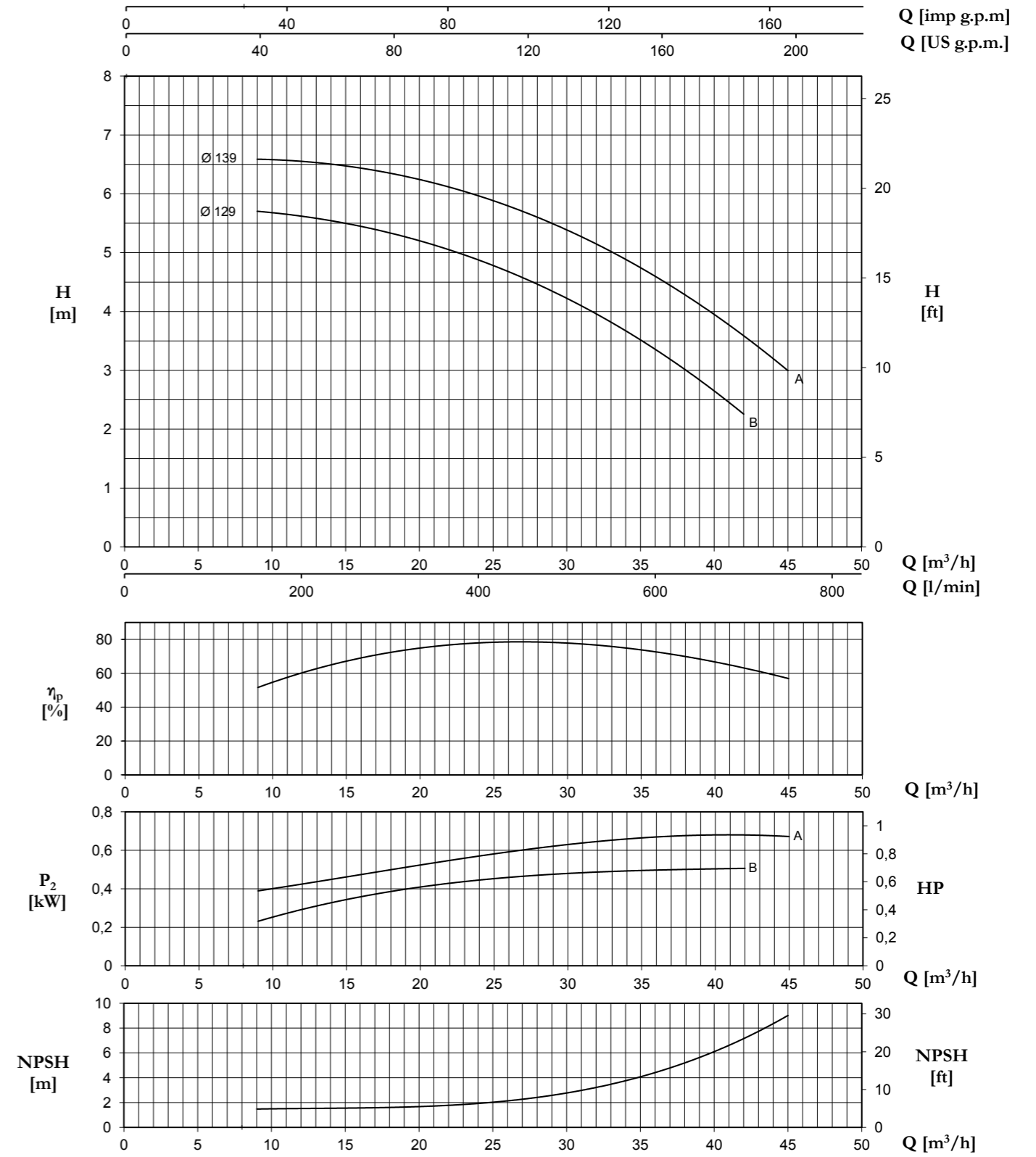

Tolerance: ISO 9906:2012 - Grade 3B

TYPE	Nominal Power (kW)	Motor Size	Q (m³/h - l/min)																
			0	9	10,5	12	15	18	21	24	27	30	33	36	39	42	45		
			0	150	175	200	250	300	350	400	450	500	550	600	650	700	750		
			H (m) / pump input power (kW)																
50-125B	0,55	80M	5,5 0,16	5,7 0,24	5,7 0,26	5,6 0,29	5,5 0,34	5,3 0,39	5,1 0,42	4,9 0,46	4,6 0,46	4,3 0,48	3,8 0,49	3,3 0,49	2,8 0,50	2,3 0,51			
50-125A	0,75	80M	6,4 0,24	6,6 0,39	6,6 0,41	6,5 0,43	6,5 0,46	6,3 0,49	6,2 0,53	6,0 0,57	5,7 0,61	5,4 0,64	5,0 0,66	4,6 0,66	4,1 0,67	3,6 0,67	3,0 0,68		

50-160

50-200

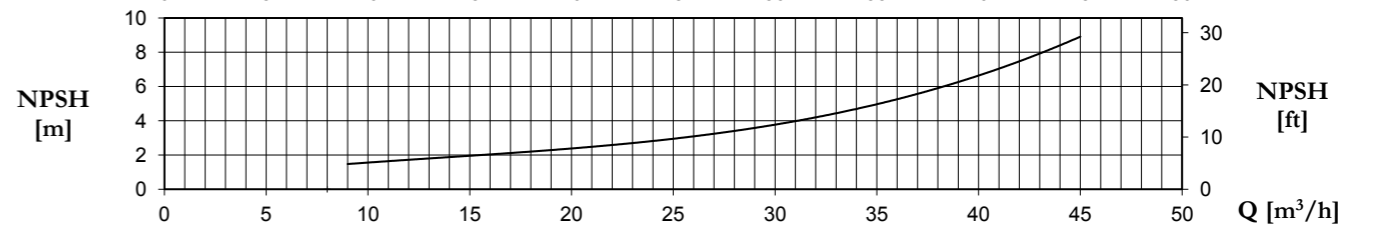
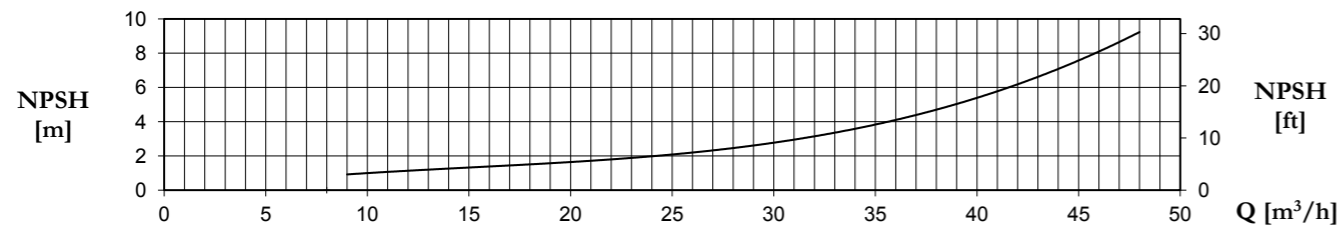
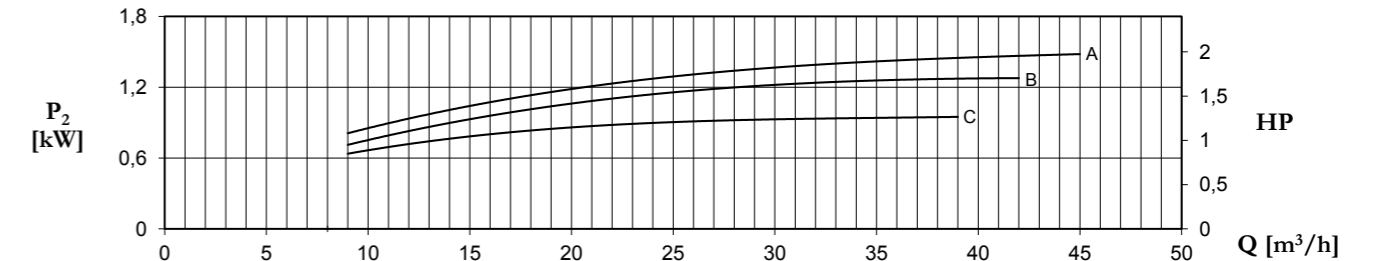
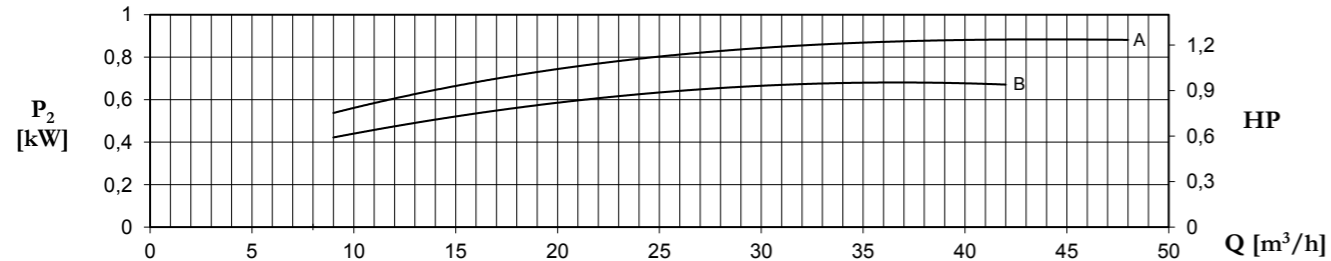
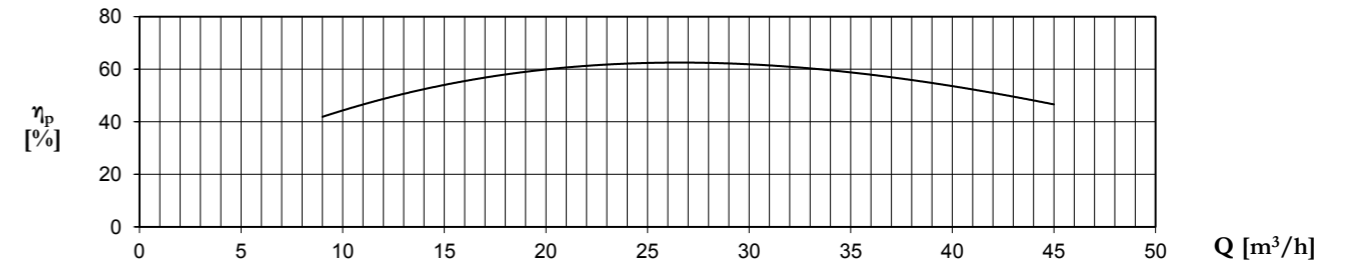
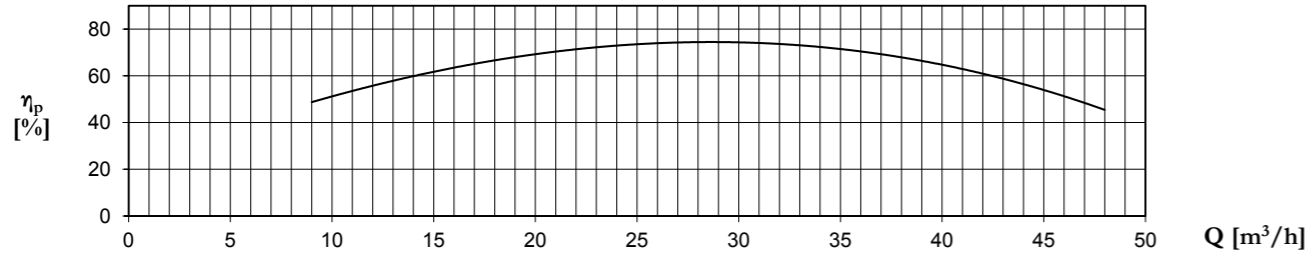
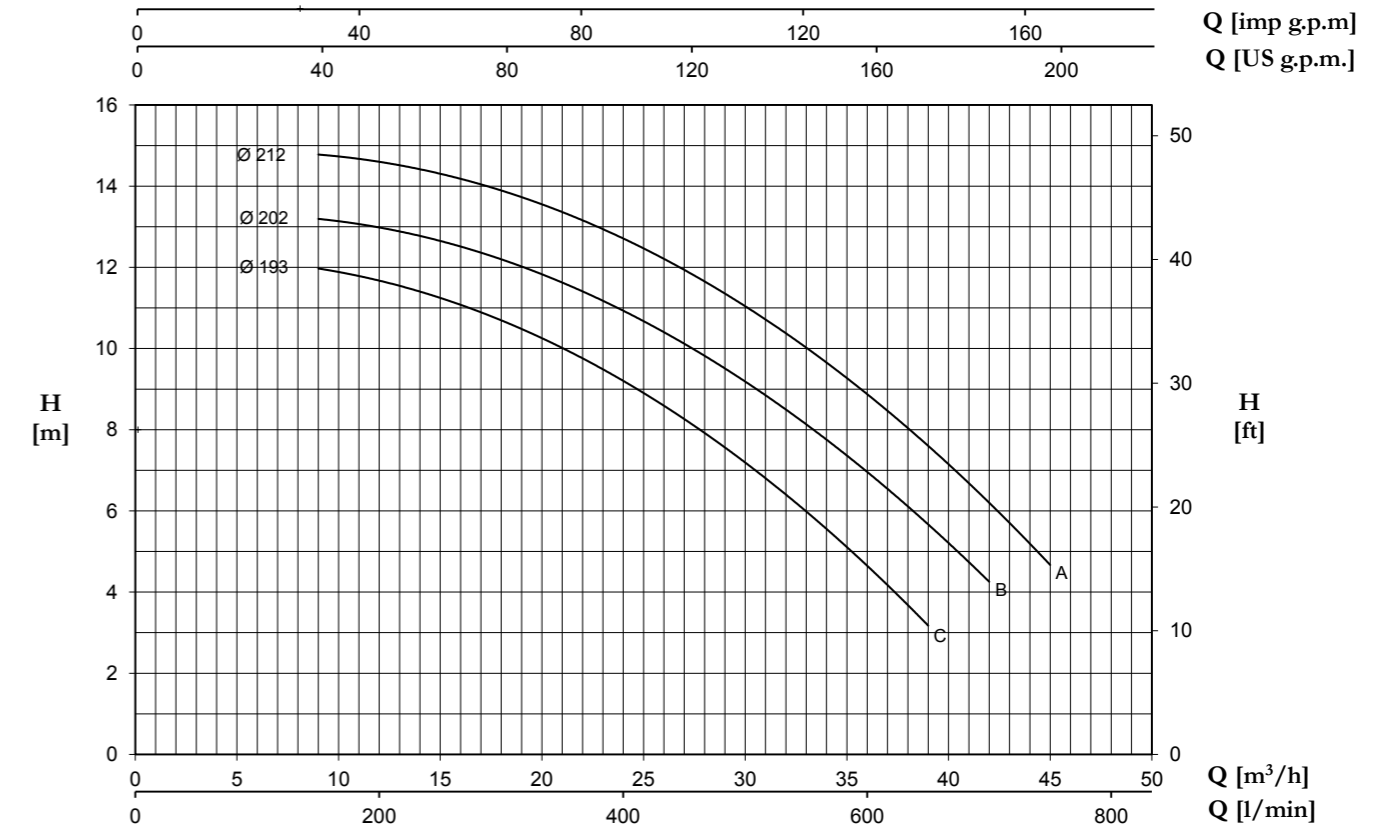
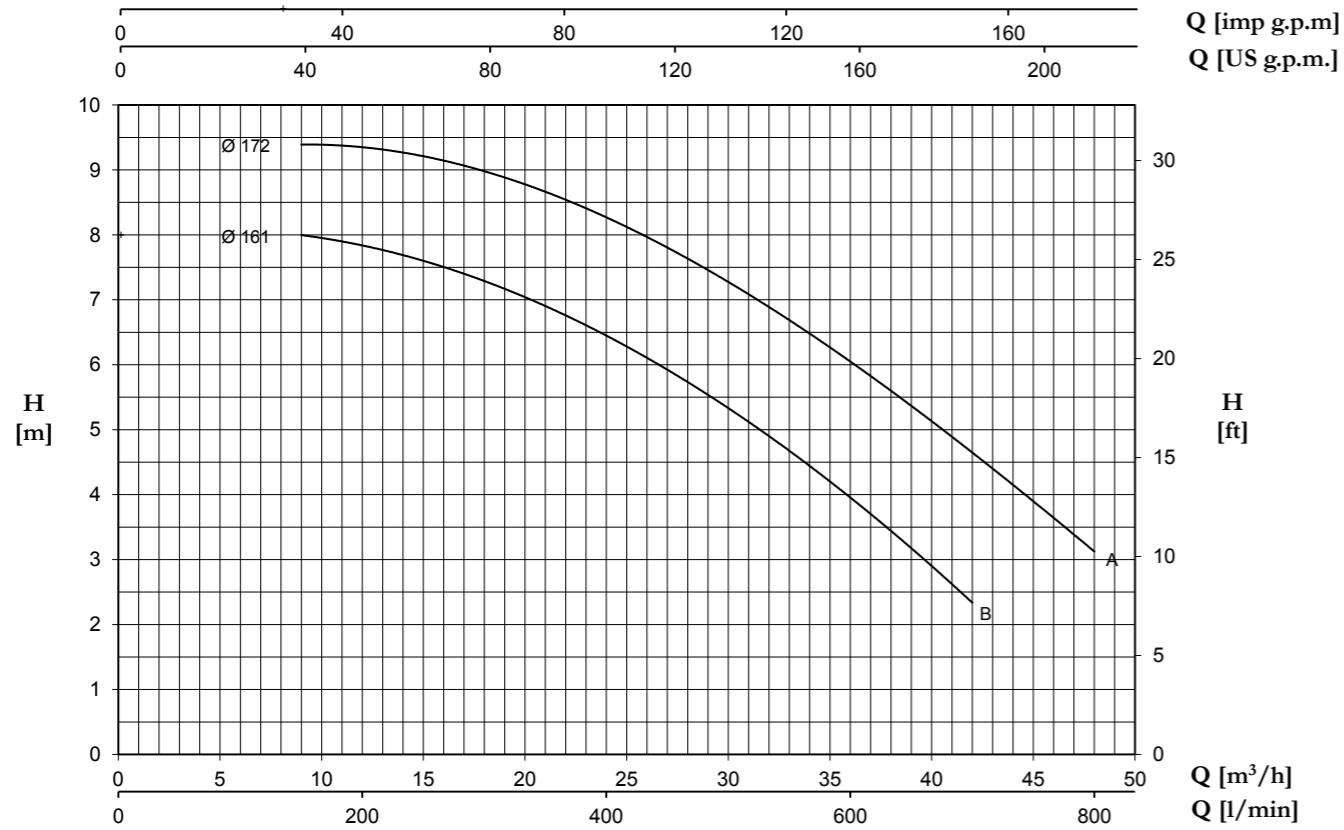

Tolerance: ISO 9906:2012 - Grade 3B

Tolerance: ISO 9906:2012 - Grade 3B

TYPE	Nominal Power (kW)	Motor Size	Q (m³/h - l/min)															
			H (m) / pump input power (kW)															
			0	9	10,5	12	15	18	21	24	27	30	33	36	39	42	45	48
50-160B	0,75	80M	7,9 0,23	8,0 0,43	7,9 0,45	7,8 0,47	7,7 0,51	7,3 0,56	6,9 0,60	6,4 0,63	5,9 0,65	5,3 0,66	4,7 0,67	4,0 0,68	3,2 0,68	2,3 0,67		
50-160A	1,1	90S	9,4 0,34	9,4 0,55	9,4 0,57	9,3 0,59	9,2 0,65	9,0 0,72	8,7 0,77	8,3 0,80	7,8 0,82	7,2 0,84	6,7 0,86	6,0 0,87	5,4 0,88	4,7 0,88	3,9 0,89	3,1 0,88

TYPE	Nominal Power (kW)	Motor Size	Q (m³/h - l/min)															
			H (m) / pump input power (kW)															
			0	9	10,5	12	15	18	21	24	27	30	33	36	39	42	45	
50-200C	1,1	90S	12,0 0,39	12,0 0,63	11,8 0,68	11,7 0,72	11,2 0,79	10,7 0,83	10,0 0,86	9,3 0,89	8,2 0,91	7,2 0,93	6,0 0,94	4,6 0,94	3,2 0,95			
50-200B	1,5	90L	13,1 0,48		13,1 0,77	13,1 0,83	12,7 0,92	12,2 1,02	11,6 1,09	10,9 1,14	10,0 1,18	9,2 1,22	8,2 1,24	7,0 1,27	5,7 1,27	4,2 1,27		
50-200A	1,5	90L	14,8 0,54		14,7 0,87	14,5 0,92	14,4 1,03	13,9 1,14	13,4 1,22	12,7 1,28	11,9 1,32	11,0 1,36	10,0 1,40	8,9 1,43	7,6 1,45	6,3 1,47	4,6 1,48	

50-250

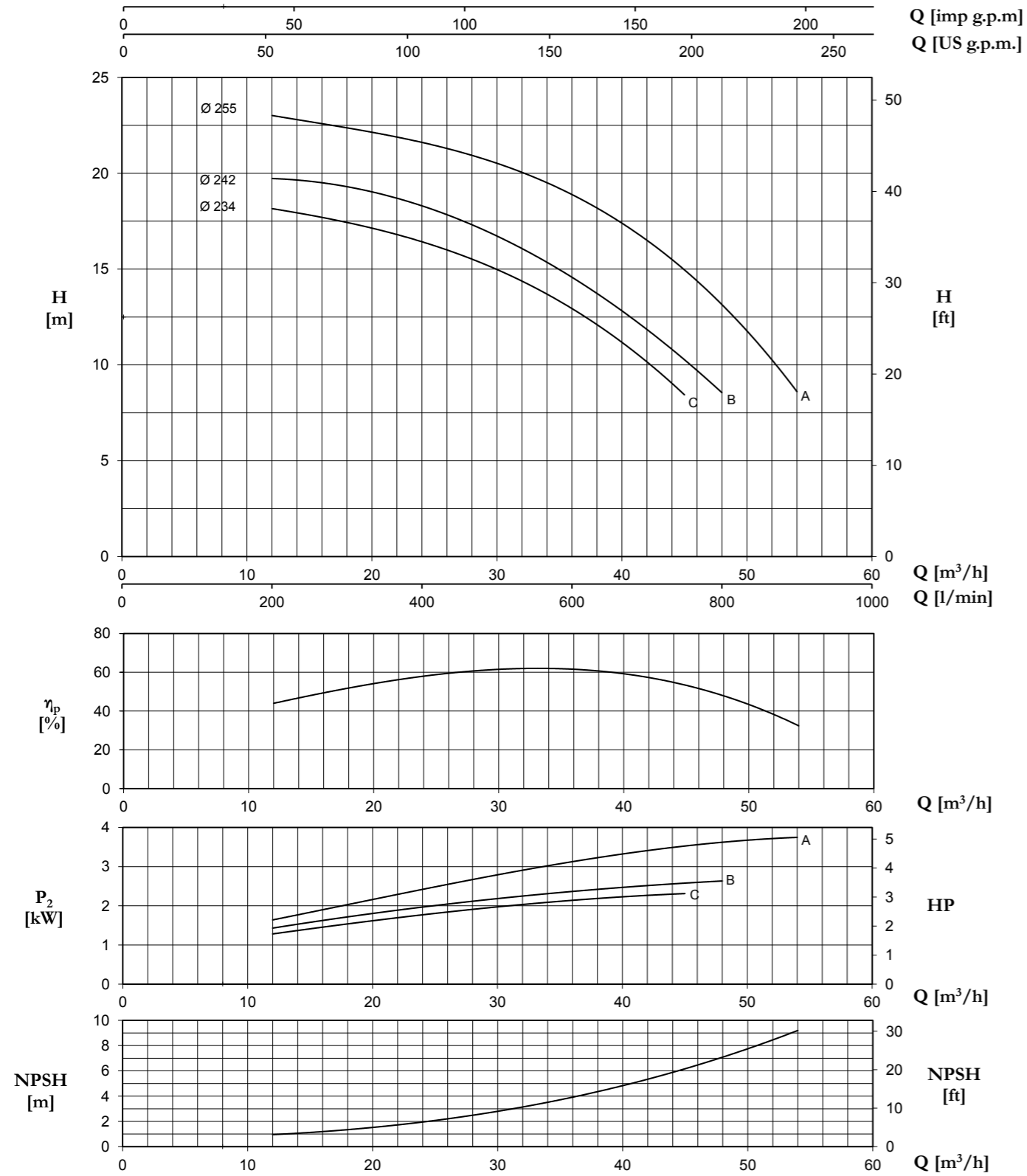

Tolerance: ISO 9906:2012 - Grade 3B

TYPE	Nominal Power (kW)	Motor Size	Q (m³/h - l/min)														
			0	12	15	18	21	24	27	30	33	36	39	42	45	48	54
			0	200	250	300	350	400	450	500	550	600	650	700	750	800	900
H (m) / pump input power (kW)																	
50-250C	2,2	100L	18,5	18,3	18,0	17,5	17,0	16,5	15,6	14,8	14,0	13,1	11,7	10,3	8,3		
	3	100L	0,61	1,30	1,38	1,53	1,66	1,79	1,88	1,98	2,06	2,14	2,20	2,26	2,32		
50-250B	3	100L	19,9		19,6	19,1	18,8	18,2	17,5	16,7	15,7	14,6	13,6	12,0	10,4	8,2	
			0,79		1,58	1,72	1,85	1,97	2,07	2,19	2,28	2,37	2,45	2,52	2,58	2,64	
50-250A	4	112M	23,0		22,7	22,5	22,2	21,8	21,1	20,4	19,5	18,7	17,7	16,6	15,2	13,4	8,4
			0,90		1,84	2,07	2,21	2,42	2,60	2,78	2,95	3,12	3,28	3,43	3,53	3,62	3,74

50-315

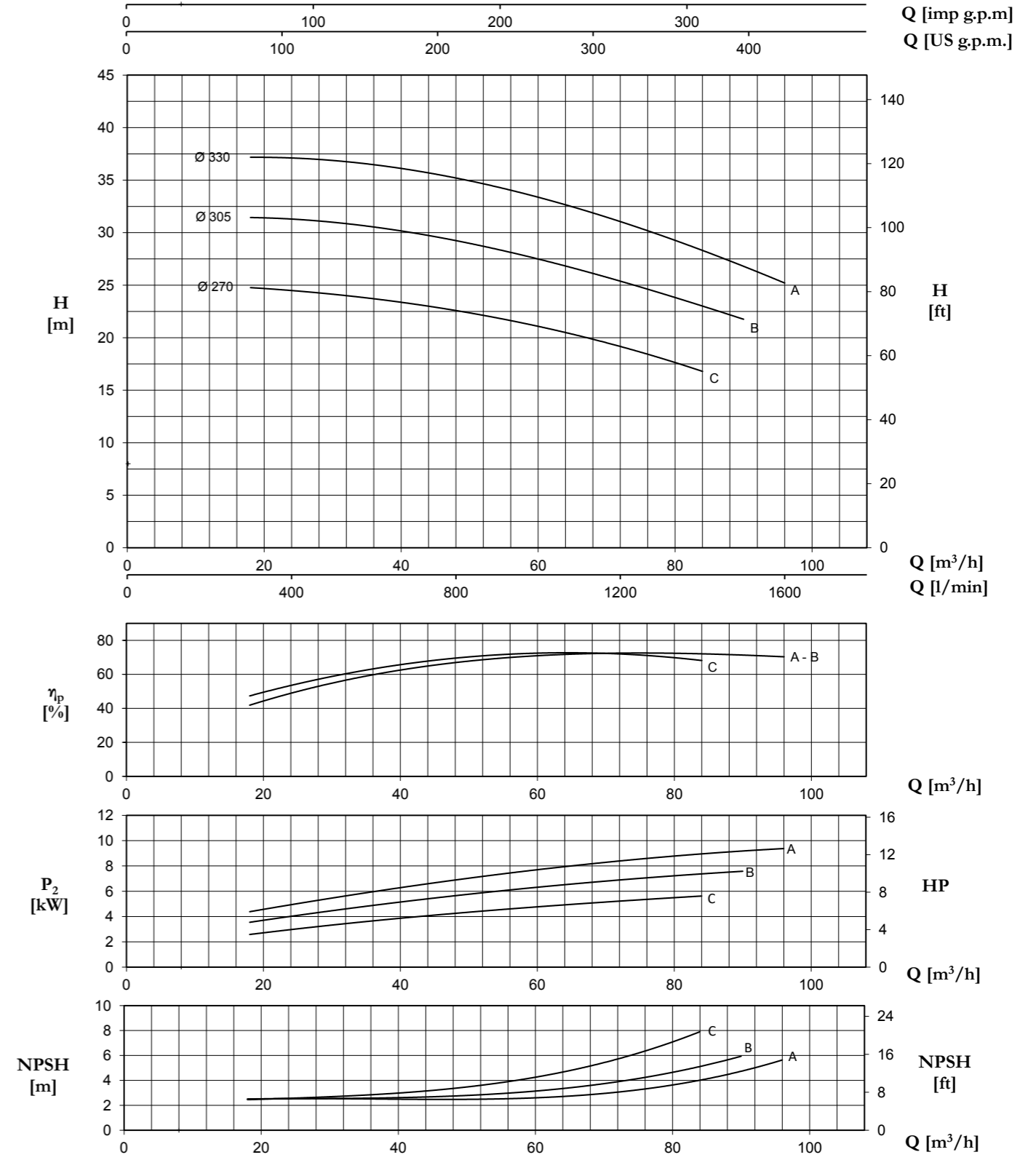

Tolerance: ISO 9906:2012 - Grade 3B

TYPE	Nominal Power (kW)	Motor Size	Q (m³/h - l/min)									
			0	18	27	36	45	60	78	84	90	96
			0	300	450	600	750	1000	1300	1400	1500	1600
H (m) / pump input power (kW)												
50-315C	5,5	132M	24,4	24,7	24,5	23,7	22,8	21,1	18,1	16,8		
			1,64	2,58	3,15	3,66	4,11	4,77	5,43	5,62		
50-315B	7,5	132M	31,3	31,4	31,3	30,6	29,5	27,3	24,4	23,1	21,6	
			2,35	3,54	4,24	4,89	5,46	6,32	7,14	7,37	7,58	
50-315A	11	160M	37,5	37,2	37,0	36,5	35,6	33,3	29,7	28,4	26,9	25,1
			3,06	4,39	5,18	5,97	6,68	7,69	8,69	8,96	9,18	9,37

65-125

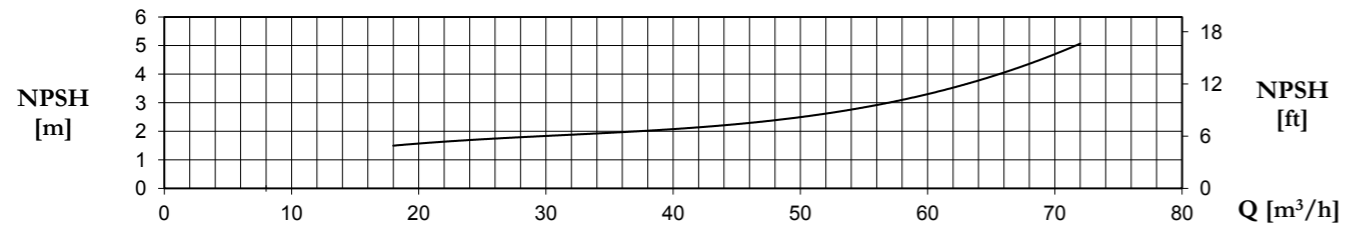
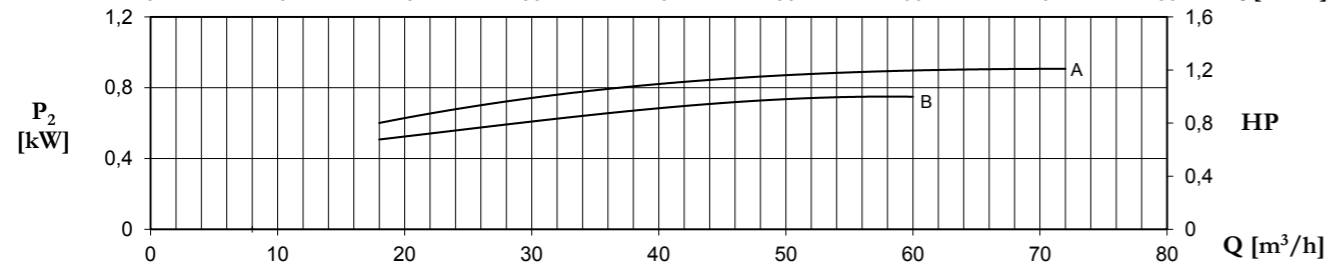
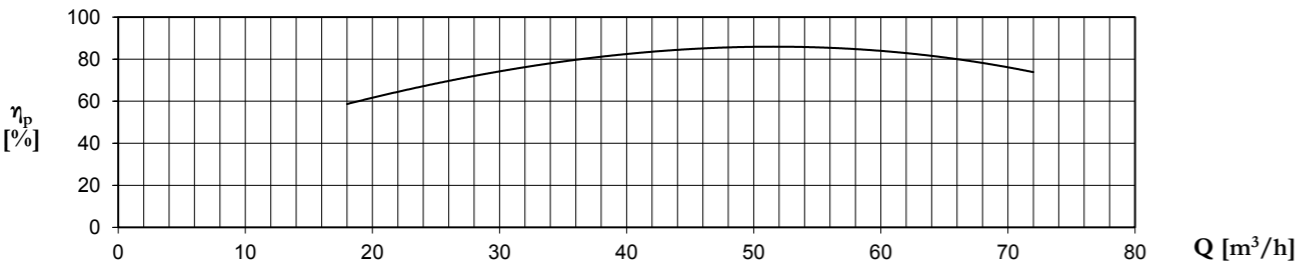
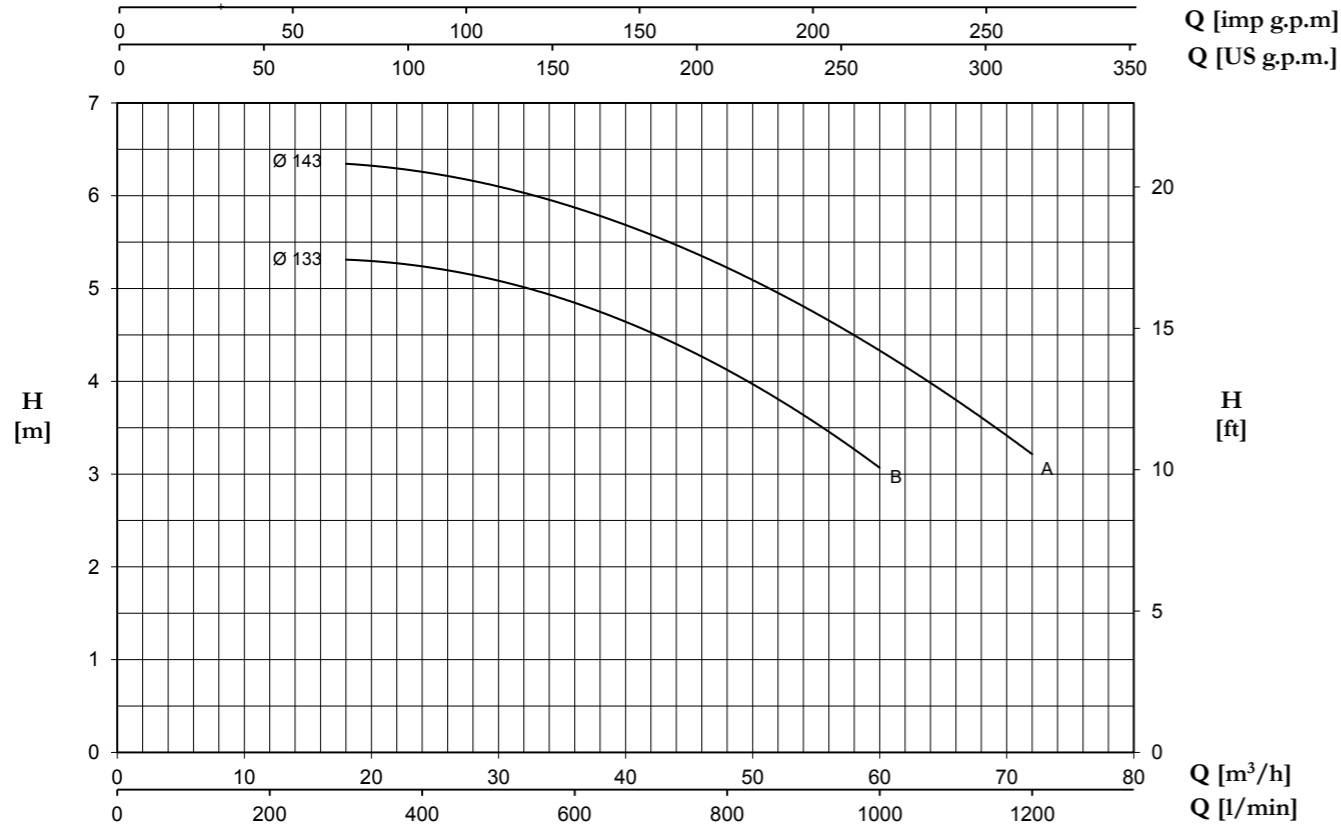

Tolerance: ISO 9906:2012 - Grade 3B

TYPE	Nominal Power (kW)	Motor Size	Q (m³/h - l/min)															
			H (m) / pump input power (kW)															
			0	18	21	24	27	30	33	36	39	42	45	48	54	60	66	72
65-125B	0,75	80M	5,1	5,3	5,3	5,2	5,2	5,1	5,0	4,8	4,7	4,6	4,3	4,1	3,6	3,1		
65-125A	1,1	90S	6,2	6,3	6,2	6,2	6,1	6,0	5,9	5,8	5,6	5,4	5,1	4,8	4,4	3,8	3,2	

65-160

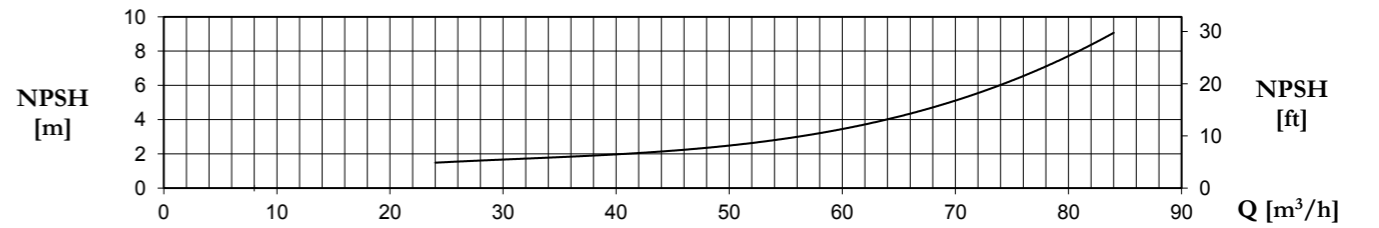
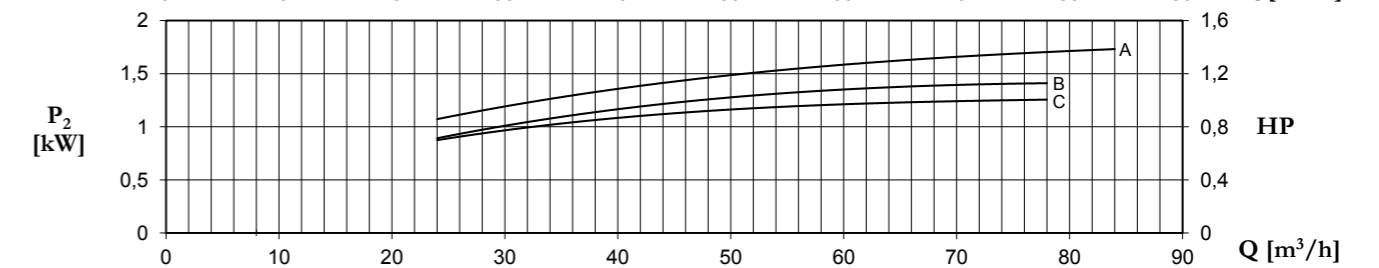
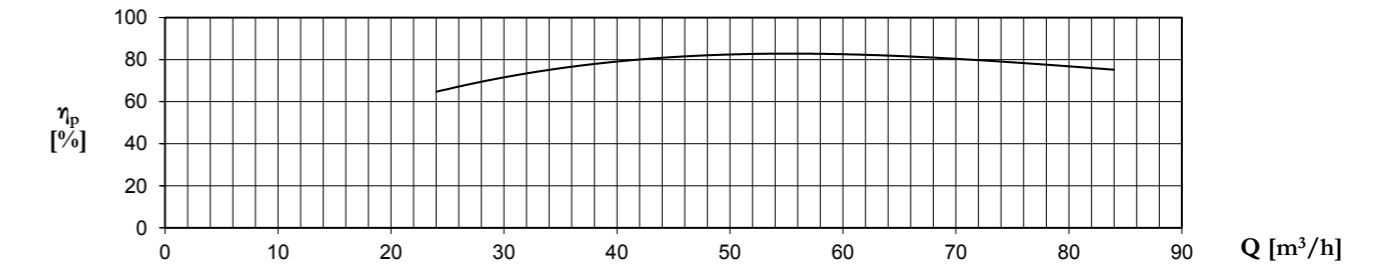
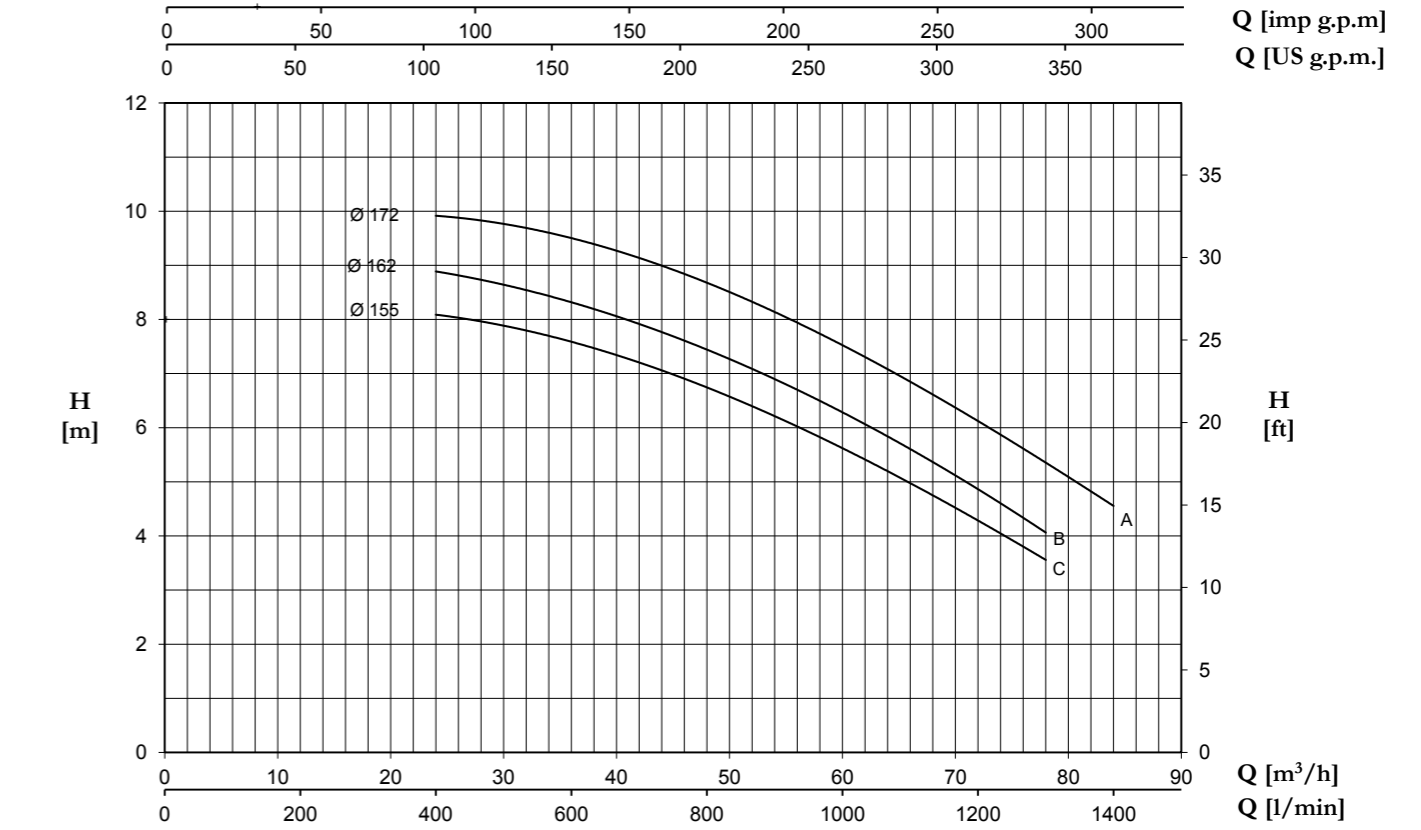

Tolerance: ISO 9906:2012 - Grade 3B

TYPE	Nominal Power (kW)	Motor Size	Q (m³/h - l/min)															
			H (m) / pump input power (kW)															
			0	24	27	30	33	36	39	42	45	48	54	60	66	72	78	84
65-160C	1,5	90L	7,8	8,1	8,0	7,9	7,7	7,6	7,4	7,2	7,0	6,7	6,3	5,6	5,0	4,2	3,6	
65-160B	1,5	90L	8,7	8,9	8,8	8,6	8,5	8,3	8,1	7,9	7,7	7,5	6,9	6,3	5,6	4,8	4,1	
65-160A	2,2	100L	9,8	9,9	9,9	9,8	9,6	9,5	9,3	9,1	8,9	8,7	8,2	7,6	6,8	6,1	5,3	4,6

65-200

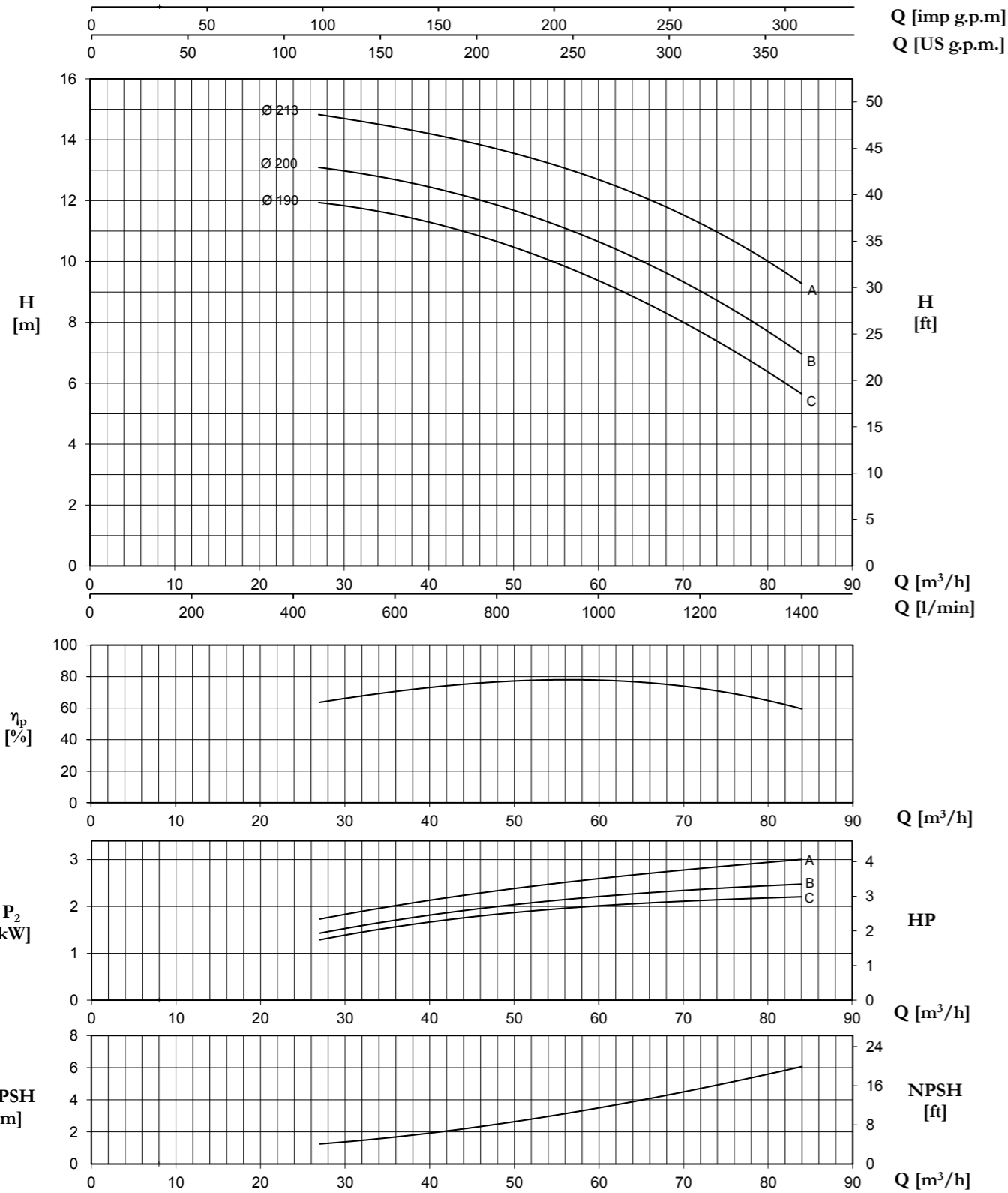

Tolerance: ISO 9906:2012 - Grade 3B

TYPE	Nominal Power (kW)	Motor Size	Q (m³/h - l/min)														
			H (m) / pump input power (kW)														
			0	27	30	33	36	39	42	45	48	54	60	66	72	78	84
65-200C	2,2	100L	11,2	11,9	11,8	11,7	11,6	11,5	11,2	10,8	10,6	10,0	9,4	8,6	7,7	6,8	5,6
65-200B	3	100L	12,3	13,1	13,0	12,8	12,7	12,5	12,3	12,1	11,9	11,3	10,6	10,0	9,0	8,0	7,0
65-200A	3	100L	14,0	14,8	14,7	14,6	14,5	14,2	14,0	13,9	13,7	13,3	12,7	12,0	11,3	10,3	9,3

65-250

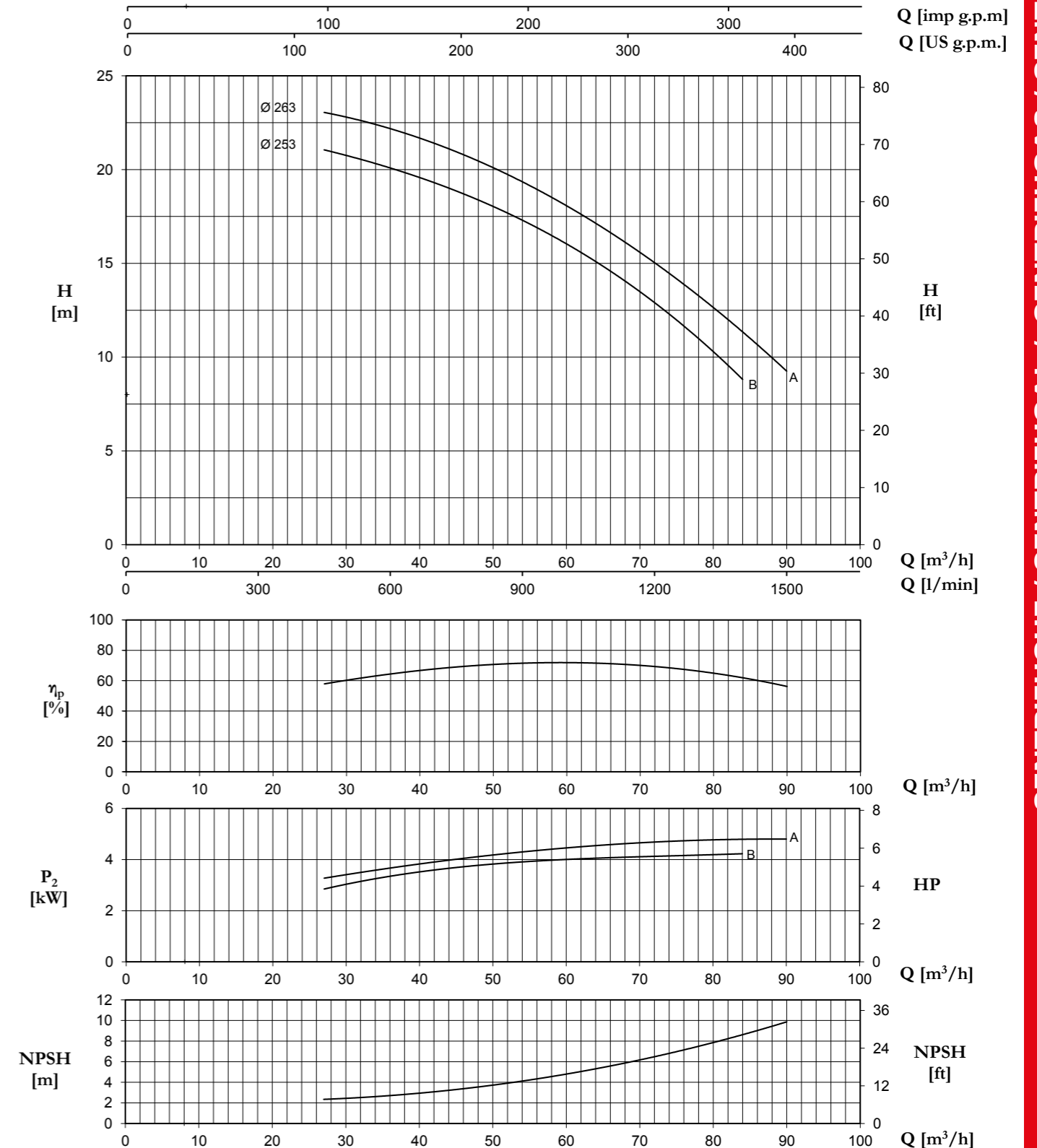

Tolerance: ISO 9906:2012 - Grade 3B

TYPE	Nominal Power (kW)	Motor Size	Q (m³/h - l/min)																
			H (m) / pump input power (kW)																
			0	27	30	33	36	39	42	45	48	54	60	66	72	78	84	90	
65-250B	4	112M	20,6	21,0	20,8	20,4	20,1	19,8	19,3	18,8	18,4	17,3	16,0	14,5	12,9	11,2	8,7		
65-250A	5,5	132S	22,8	22,9	22,5	22,1	21,7	21,4	20,9	20,4	19,2	18,0	16,9	15,4	13,6	11,5	8,8		

4MA/4MAT - 4MAX EN 733 ~ 1450 r.p.m.

65-315

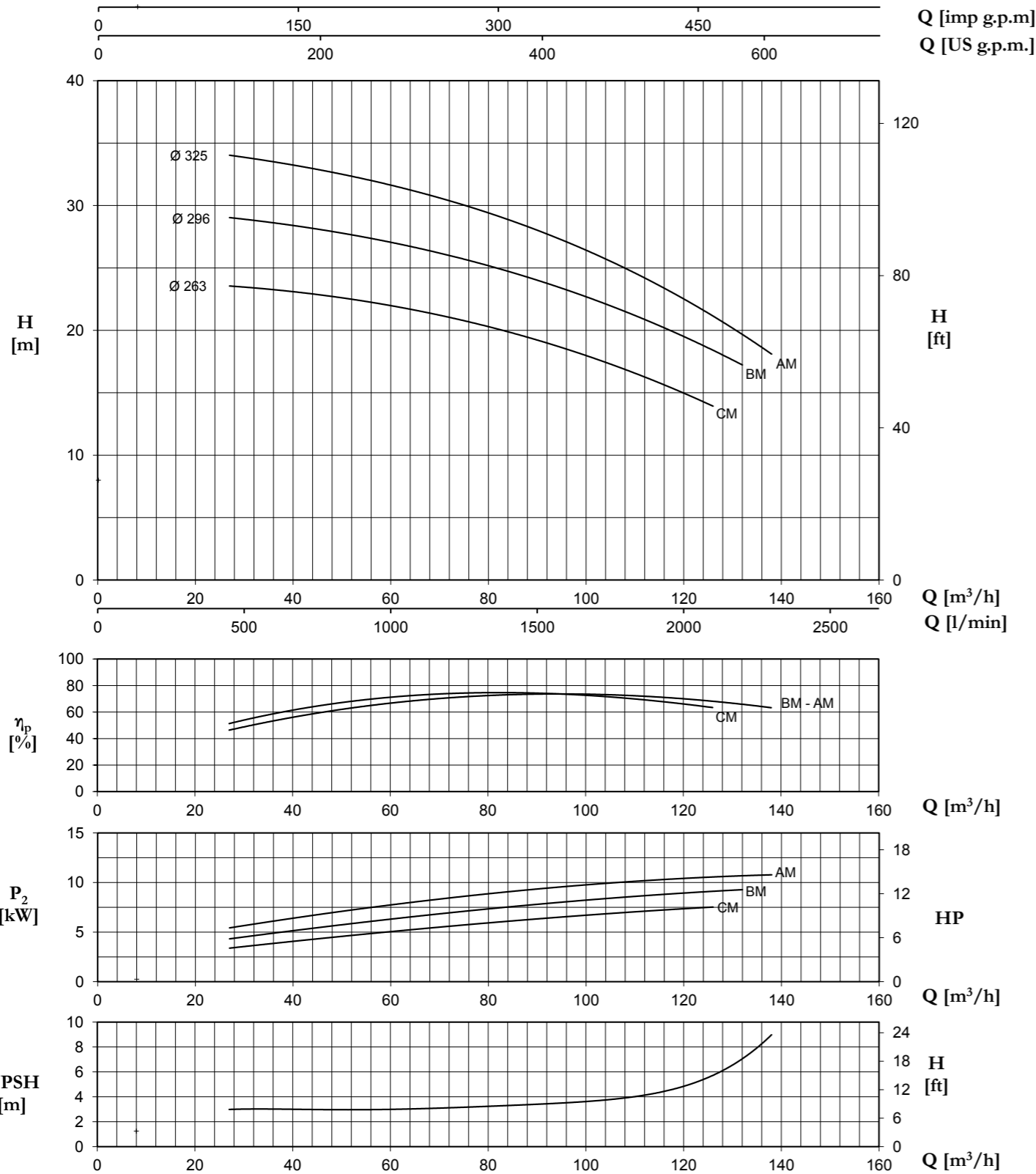

Tolerance: ISO 9906:2012 - Grade 3B

TYPE	Nominal Power (kW)	Motor Size	Q (m³/h - l/min)																		
			0	27	36	45	60	78	102	126	132	138									
			0	450	600	750	1000	1300	1700	2100	2200	2300									
			H (m) / pump input power (kW)																		
65-315 CM	7,5	132M	23,0 2,05	23,5 3,38	23,3 3,86	22,9 4,32	21,9 5,05	20,5 5,84	17,7 6,77	13,9 7,52											
65-315 BM	11	160M	28,9 2,72	28,9 4,33	28,7 4,89	28,2 5,42	27,0 6,33	25,3 7,24	22,5 8,30	18,4 9,10	17,2 9,29										
65-315 AM	11	160M	34,5 3,44	34,0 5,43	33,5 6,10	32,9 6,75	31,6 7,73	29,6 8,78	26,2 9,84	21,1 10,55	19,6 10,68	18,2 10,78									

~ 1450 r.p.m. 4MA/4MAT - 4MAX EN 733

80-160

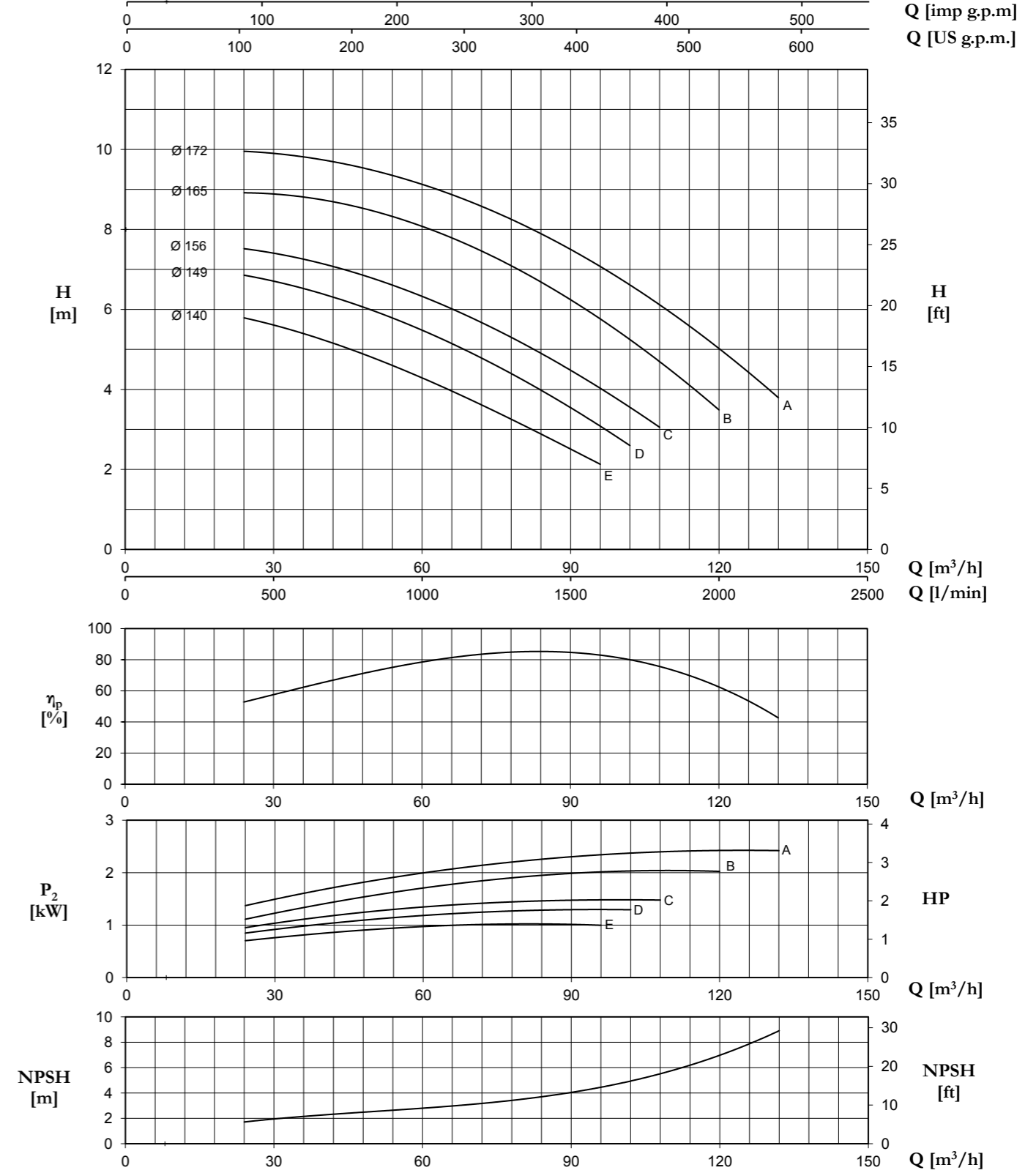

Tolerance: ISO 9906:2012 - Grade 3B

TYPE	Nominal Power (kW)	Motor Size	Q (m³/h - l/min)																		
			0	24	27	30	33	36	42	48	60	72	84	96	102	108	120	132			
			0	400	450	500	550	600	700	800	1000	1200	1400	1600	1700	1800	2000	2200			
			H (m) / pump input power (kW)																		
80-160E	1,1	90S	5,5 0,35	5,7 0,71	5,7 0,74	5,7 0,74	5,6 0,78	5,4 0,81	5,1 0,88	4,9 0,90	4,2 0,97	3,8 1,02	2,8 1,02	2,2 1,00							
80-160D	1,5	90L	6,3 0,61		6,8 0,89	6,7 0,91	6,6 0,95	6,5 0,98	6,3 1,04	6,1 1,10	5,5 1,19	4,8 1,25	4 1,28	3,1 1,30	2,6 1,29						
80-160C	1,5	90L	7 0,67			7,4 1,04	7,3 1,08	7,3 1,12	7,1 1,18	6,8 1,25	6,4 1,35	5,7 1,42	4,9 1,47	4 1,48	3,5 1,48	3,1 1,48					
80-160B	2,2	100L	8,5 0,82				8,9 1,29	8,9 1,35	8,7 1,43	8,5 1,51	8,0 1,72	7,5 1,87	6,8 1,95	5,7 2,01	5,2 2,02	4,7 2,04	3,5 2,04				
80-160A	3	100L	9,3 1,09					9,8 1,60	9,7 1,71	9,5 1,81	9,1 2,01	8,6 2,14	7,9 2,27	7,1 2,34	6,6 2,37	6,2 2,39	5,0 2,42	3,8 2,43			

4MA/4MAT - 4MAX EN 733 ~ 1450 r.p.m.

80-200

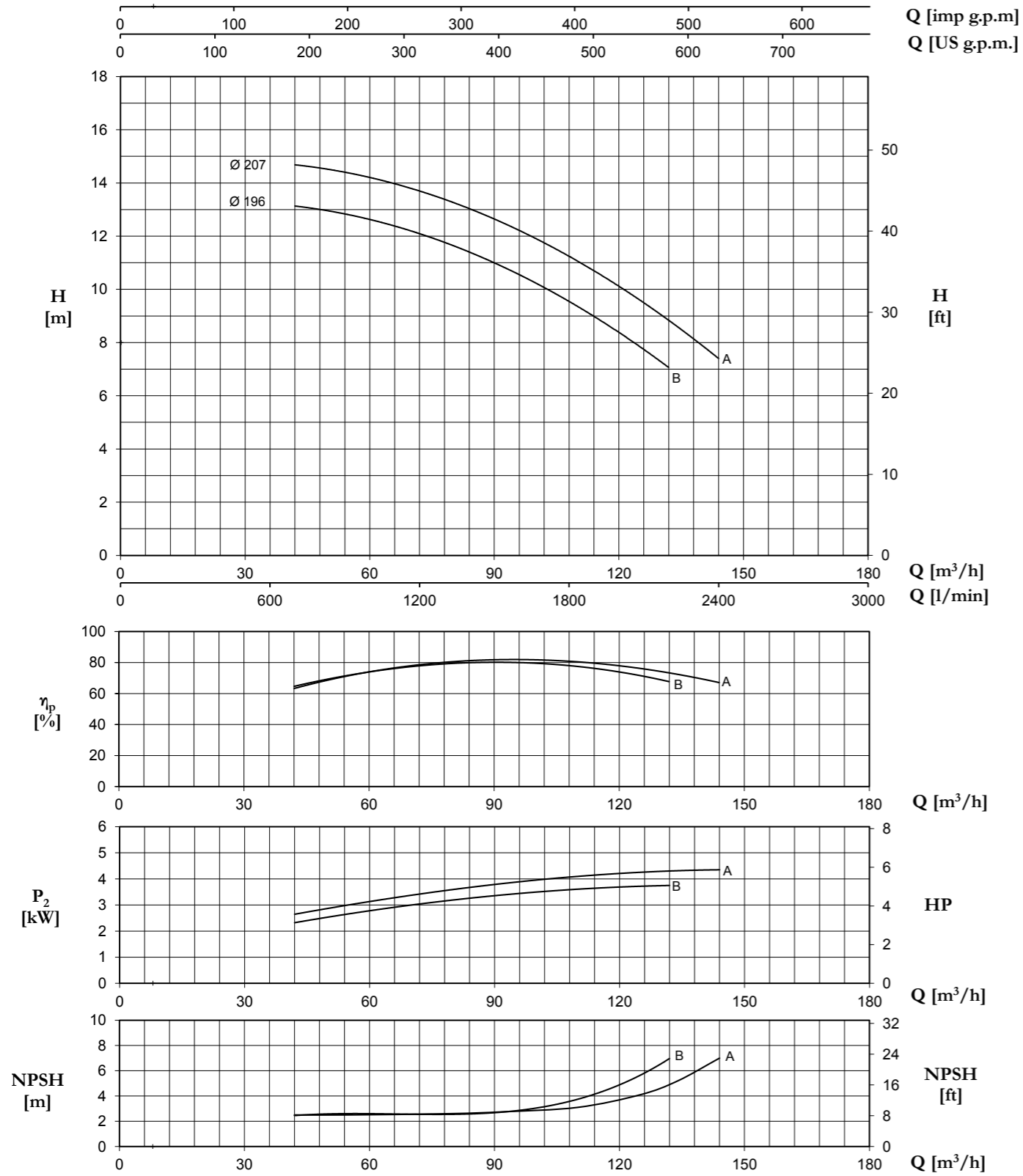

Tolerance: ISO 9906:2012 - Grade 3B

TYPE	Nominal Power (kW)	Motor Size	Q (m³/h - l/min)												
			0	42	60	84	96	102	108	120	132	144			
			0	700	1000	1400	1600	1700	1800	2000	2200	2400			
			H (m) / pump input power (kW)												
80-200B	4	112M	12,3	13,1	12,6	11,4	10,5	10,1	9,6	8,4	7,1				
			1,25	2,32	2,79	3,26	3,45	3,52	3,58	3,69	3,75				
80-200A	5,5	132S	13,8	14,7	14,2	13,1	12,3	11,7	11,2	10,1	8,8	7,5			
			1,40	2,64	3,14	3,66	3,87	3,99	4,09	4,21	4,30	4,35			

~ 1450 r.p.m. 4MA/4MAT - 4MAX EN 733

80-250

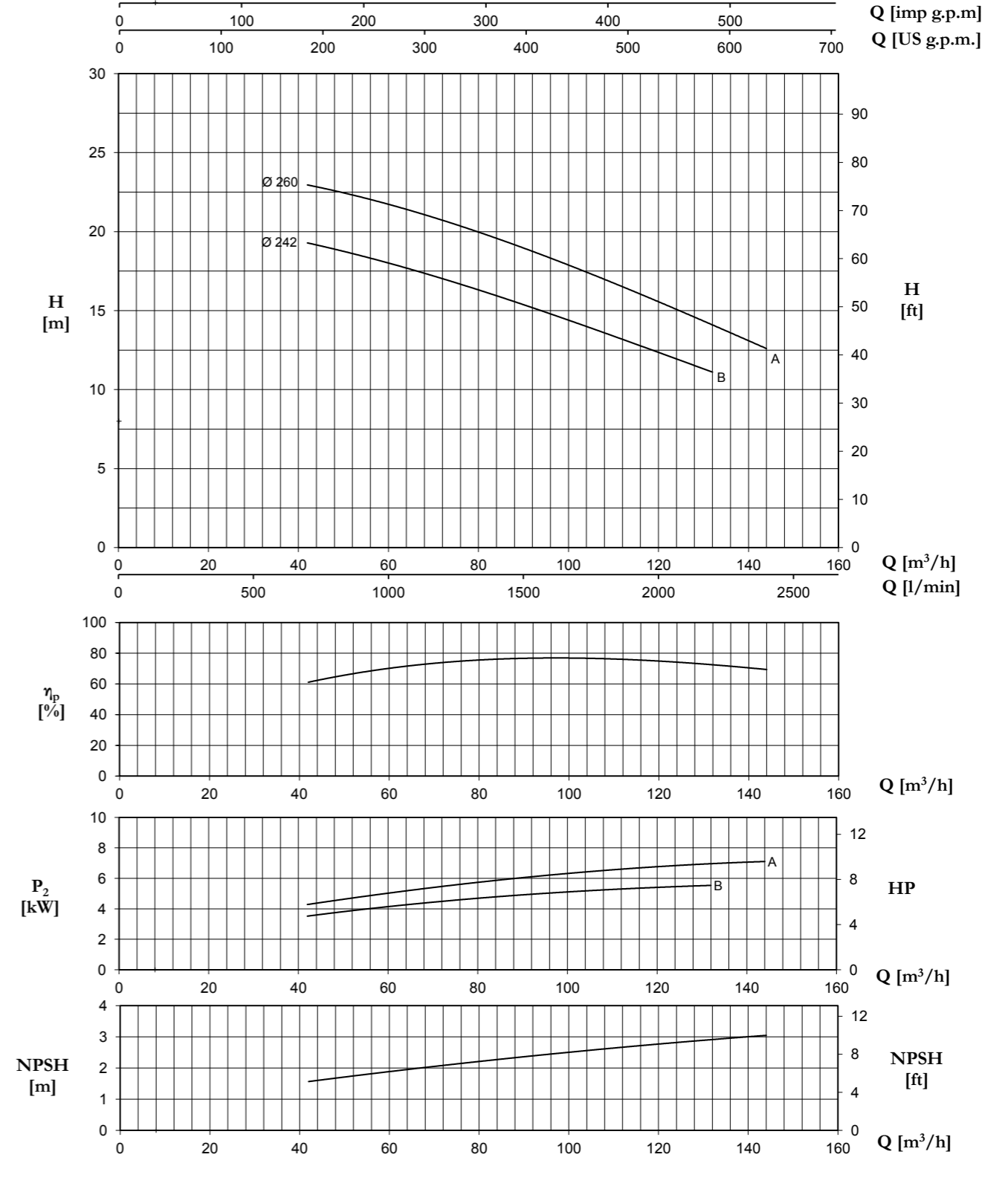

Tolerance: ISO 9906:2012 - Grade 3B

TYPE	Nominal Power (kW)	Motor Size	Q (m³/h - l/min)													
			0	42	48	60	72	84	96	102	108	120	132	144		
			0	700	800	1000	1200	1400	1600	1700	1800	2000	2200	2400		
			H (m) / pump input power (kW)													
80-250B	5,5	132S	18,9	19,2	19,0	18,1	17,0	15,9	14,8	14,2	13,6	12,4	11,1			
			1,79	3,52	3,75	4,14	4,48	4,78	5,05	5,16	5,24	5,41	5,54			
80-250A	7,5	132S	22,4	22,9	22,6	21,8	20,7	19,6	18,3	17,7	17,0	15,6	14,2	12,6		
			2,22	4,28	4,56	5,05	5,46	5,85	6,21	6,37	6,52	6,77	6,96	7,10		

80-315

100-200

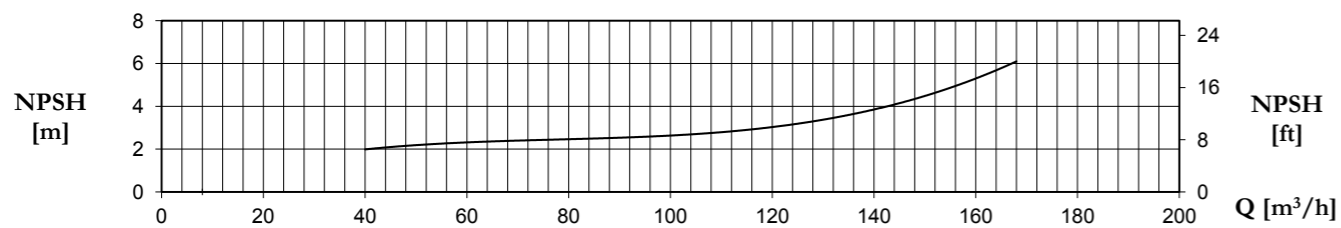
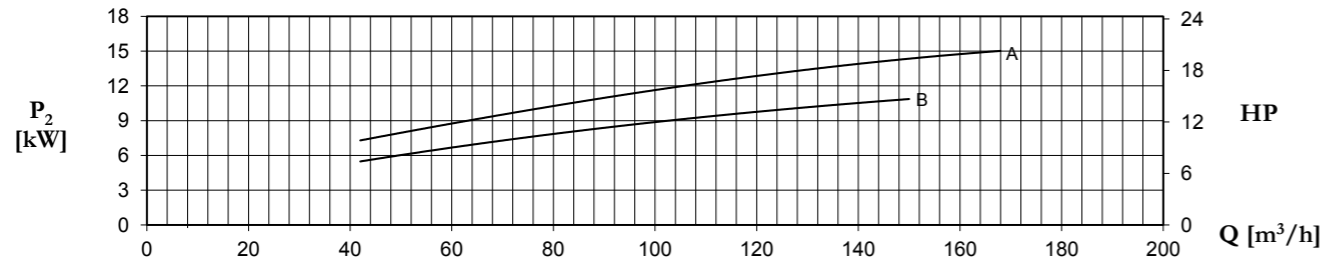
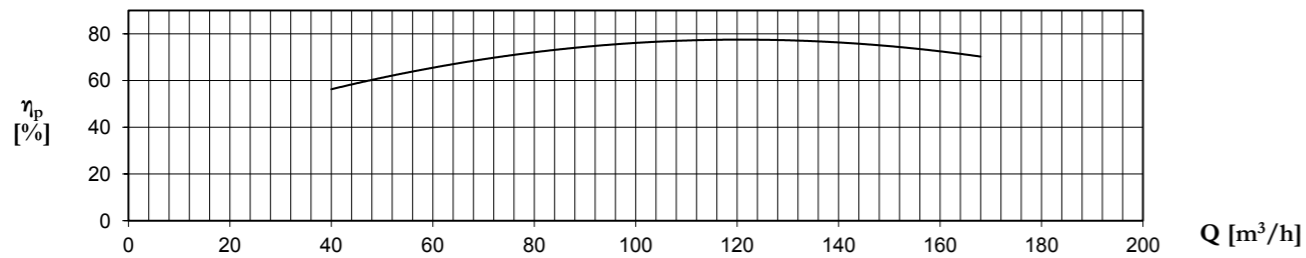
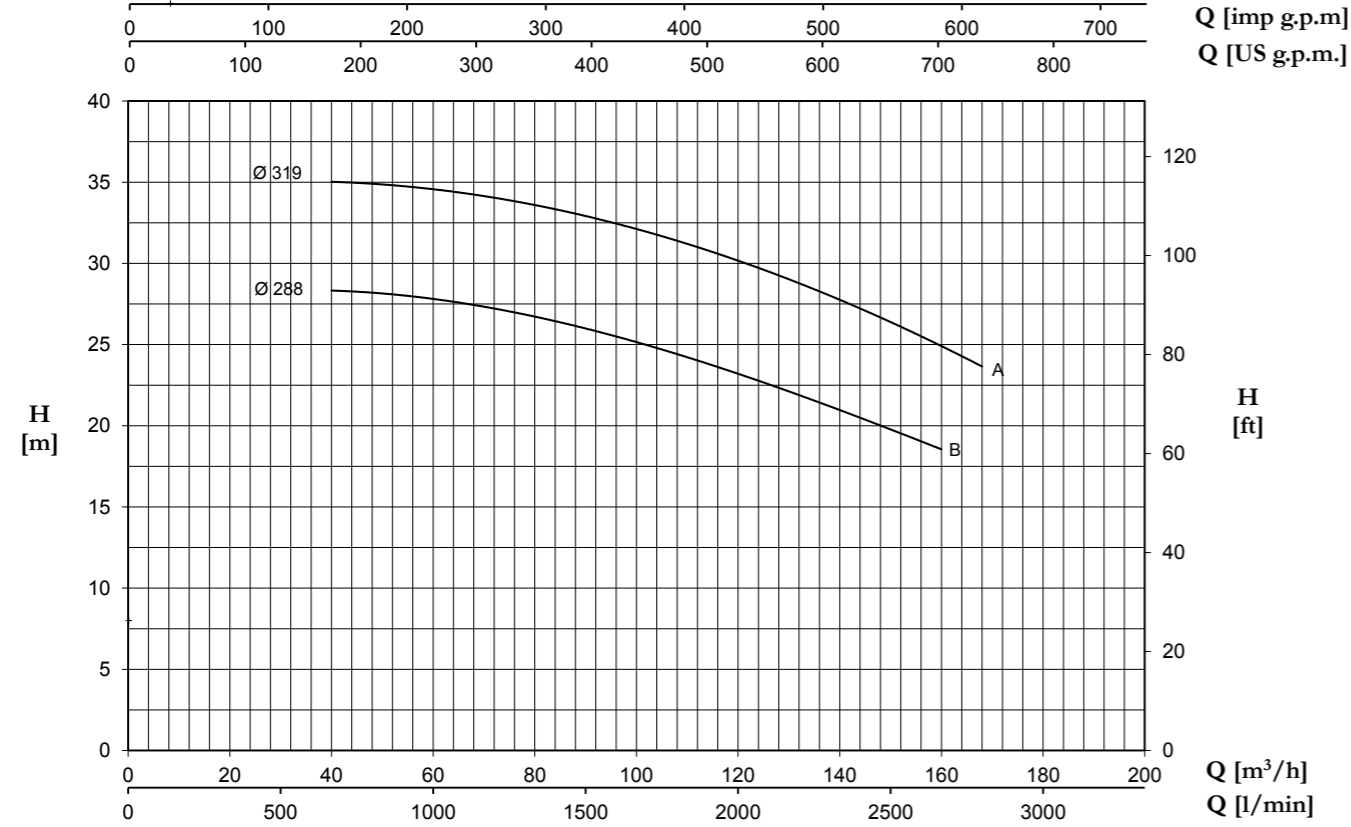

Tolerance: ISO 9906:2012 - Grade 3B

TYPE	Nominal Power (kW)	Motor Size	Q (m³/h - l/min)															
			0	48	60	72	84	96	102	108	120	132	144	150	156	168		
			0	800	1000	1200	1400	1600	1700	1800	2000	2200	2400	2500	2600	2800		
			H (m) / pump input power (kW)															
80-315B	11	160M	27,7 2,89	28,2 5,88	27,9 6,67	27,2 7,42	26,4 8,09	25,4 8,67	24,9 8,95	24,4 9,21	23,2 9,74	21,9 10,28	20,5 10,69	19,9 10,87				
80-315A	15	160L	34,5 4,29	34,9 7,79	34,6 8,75	34,1 9,66	33,3 10,53	32,4 11,36	31,9 11,77	31,3 12,17	30,1 12,91	28,8 13,50	27,3 14,04	26,4 14,31	25,6 14,56	23,7 15,04		

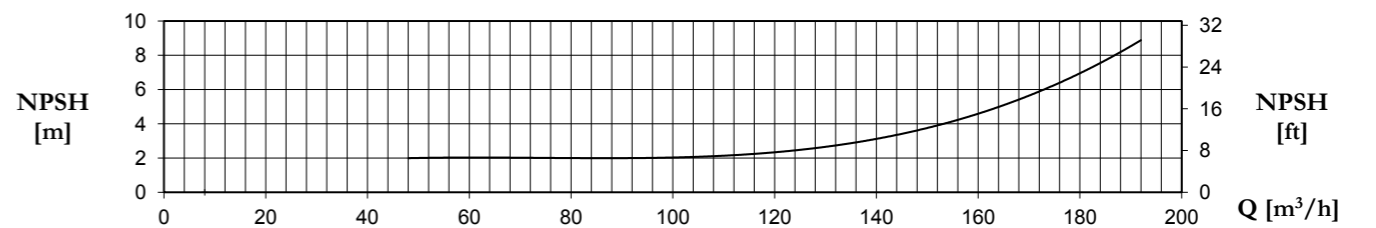
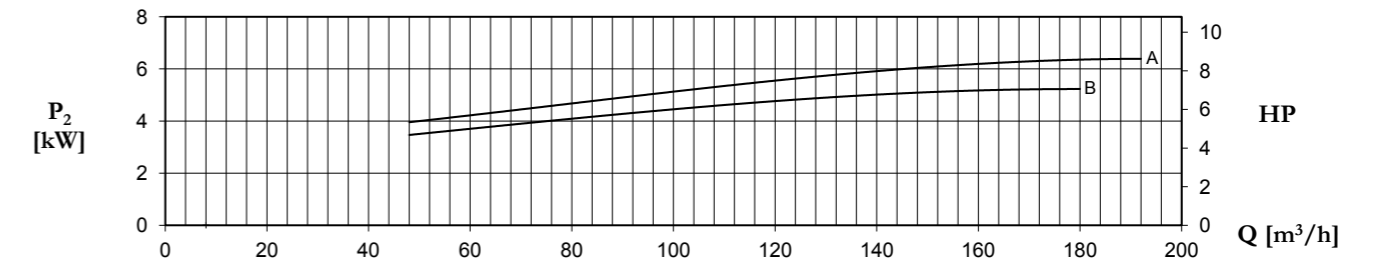
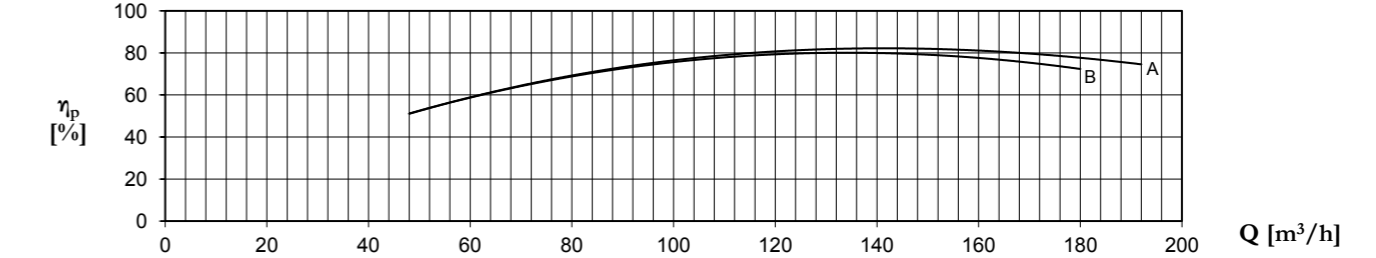
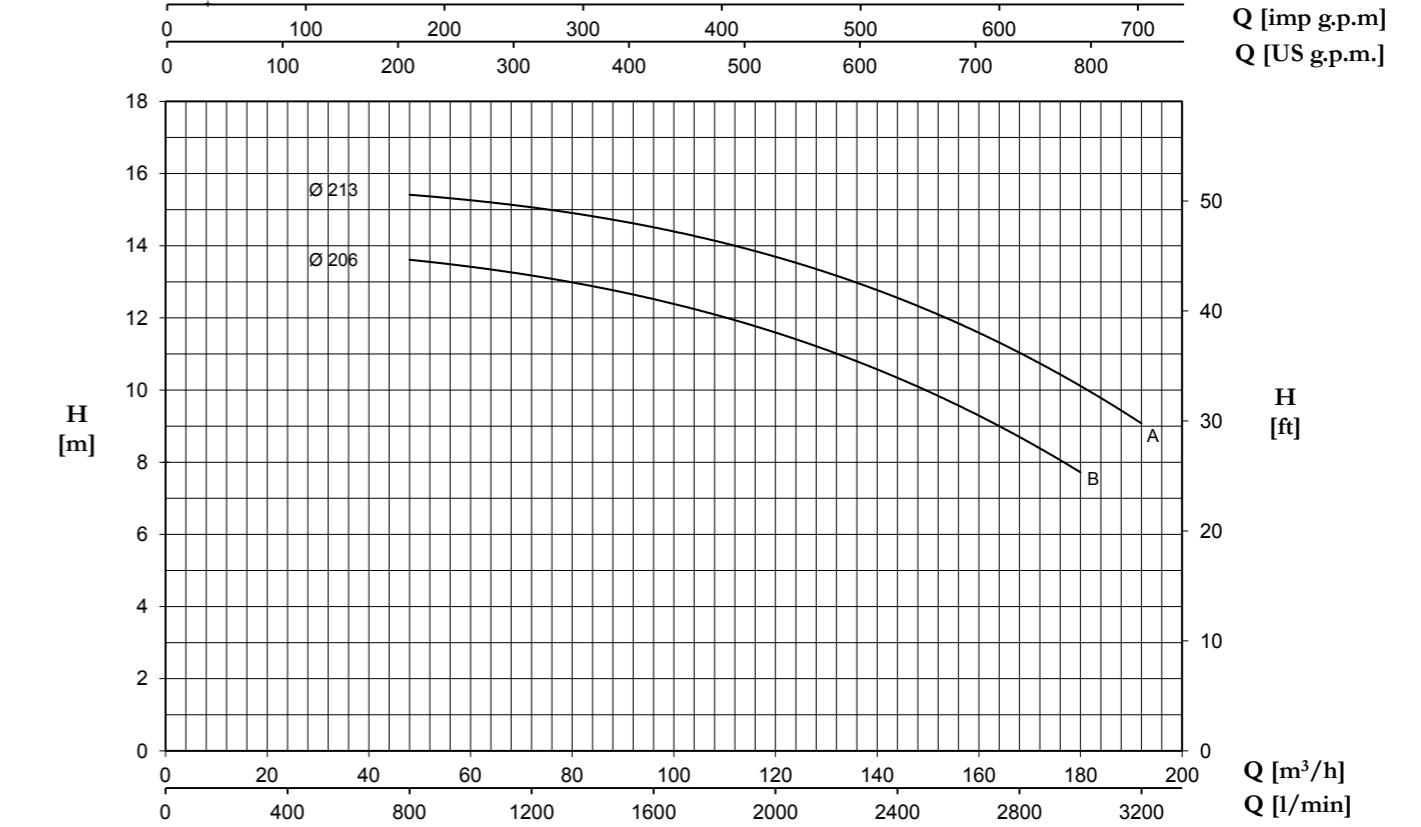

Tolerance: ISO 9906:2012 - Grade 3B

TYPE	Nominal Power (kW)	Motor Size	Q (m³/h - l/min)																	
			0	48	60	72	84	96	102	108	120	132	144	150	156	168	180	192		
			0	800	1000	1200	1400	1600	1700	1800	2000	2200	2400	2500	2600	2800	3000	3200		
			H (m) / pump input power (kW)																	
100-200B	5,5	132S	13,5 2,79	13,6 3,48	13,4 3,70	13,1 3,93	12,8 4,15	12,5 4,38	12,3 4,49	12,1 4,59	11,6 4,77	11,0 4,93	10,3 5,05	9,9 5,09	9,5 5,13	8,7 5,19	7,8 5,23			
100-200A	7,5	132M	15,2 3,12	15,4 3,96	15,3 4,22	15,0 4,48	14,8 4,74	14,5 5,03	14,4 5,17	14,2 5,31	13,8 5,58	13,2 5,80	12,5 5,99	12,2 6,07	11,8 6,13	11,0 6,23	10,1 6,33	9,1 6,40		

100-250

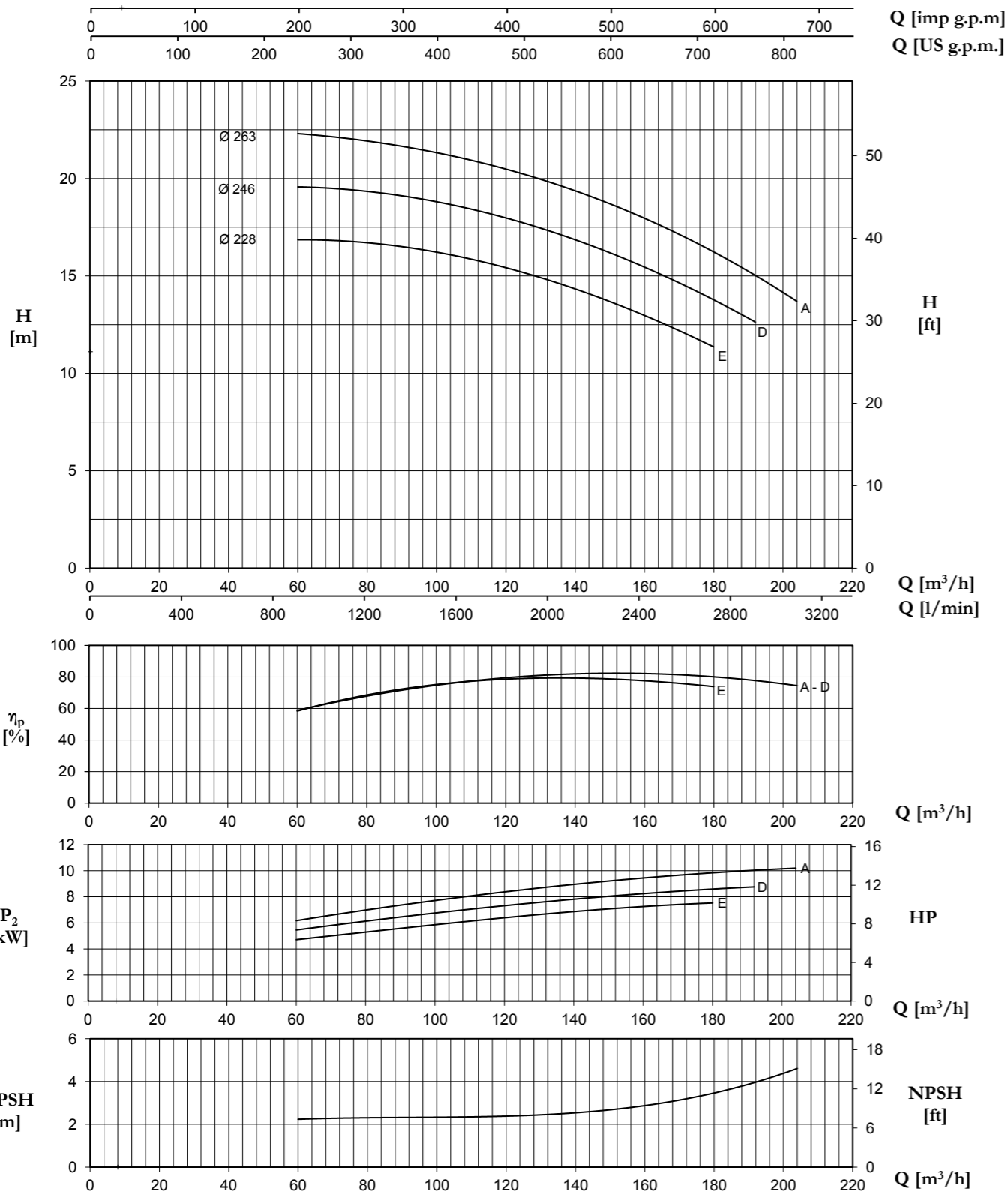

Tolerance: ISO 9906:2012 - Grade 3B

TYPE	Nominal Power (kW)	Motor Size	Q (m³/h - l/min)															
			0	60	72	84	96	102	108	120	132	144	150	156	168	192	204	
			0	1000	1200	1400	1600	1700	1800	2000	2200	2400	2500	2600	2800	3200	3400	
			H (m) / pump input power (kW)															
100-250E	7,5	132M	16,7 3,06	16,9 4,71	16,8 5,06	16,6 5,42	16,3 5,75	16,2 5,91	16,0 6,07	15,5 6,39	14,8 6,69	14,0 6,96	13,6 7,08	13,2 7,19	12,4 7,38			
100-250D	7,5 11	132M 160M	19,6 3,39	19,6 5,44	19,4 5,88	19,2 6,29	18,9 6,66	18,7 6,82	18,5 6,98	18,0 7,30	17,4 7,60	16,6 7,90	16,2 8,05	15,7 8,19	14,8 8,41	12,7 8,75		
100-250A	11	160M	22,6 3,96	22,3 6,17	22,1 6,67	21,8 7,15	21,4 7,59	21,2 7,80	21,0 8,00	20,5 8,37	19,9 8,71	19,1 9,04	18,7 9,20	18,3 9,36	17,3 9,63	15,0 10,04	13,8 10,19	

100-315

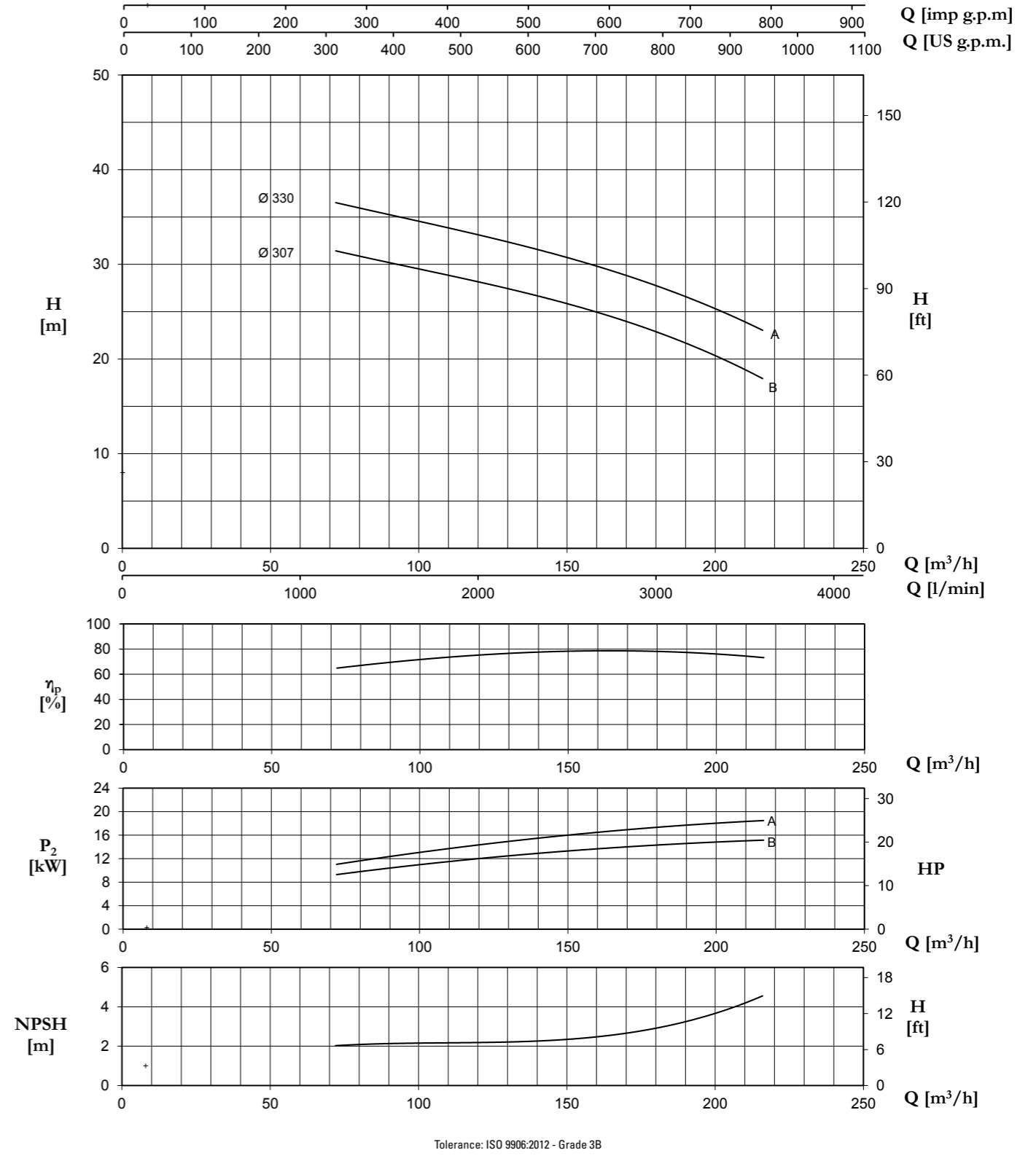

Tolerance: ISO 9906:2012 - Grade 3B

TYPE	Nominal Power (kW)	Motor Size	Q (m³/h - l/min)										
			0	72	78	84	108	132	156	180	204	216	
			0	1200	1300	1400	1800	2200	2600	3000	3400	3600	
			H (m) / pump input power (kW)										
100-315B	15	160L	31,8 4,74	31,4 9,27	31,0 9,67	30,6 10,05	29,0 11,42	27,3 12,54	25,3 13,54	23,0 14,31	19,7 14,92	17,9 15,14	
100-315A	18,5	180M	37,1 5,63	36,5 11,03	36,1 11,49	35,7 11,94	34,0 13,60	32,2 15,01	30,2 16,32	27,9 17,32	24,7 18,15	23,1 18,49	

4MA/4MAT - 4MAX EN 733 ~ 1450 r.p.m.

100-400

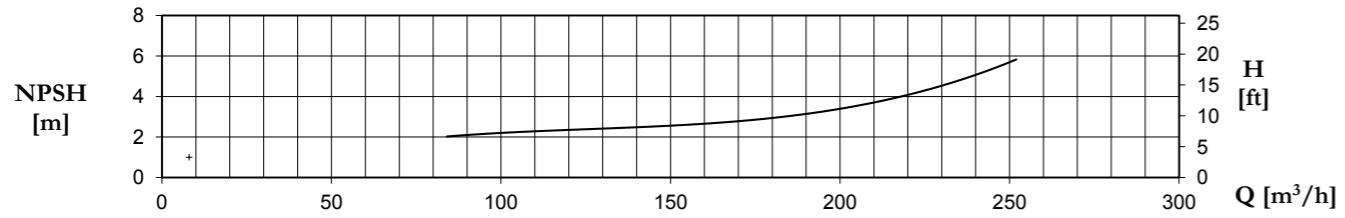
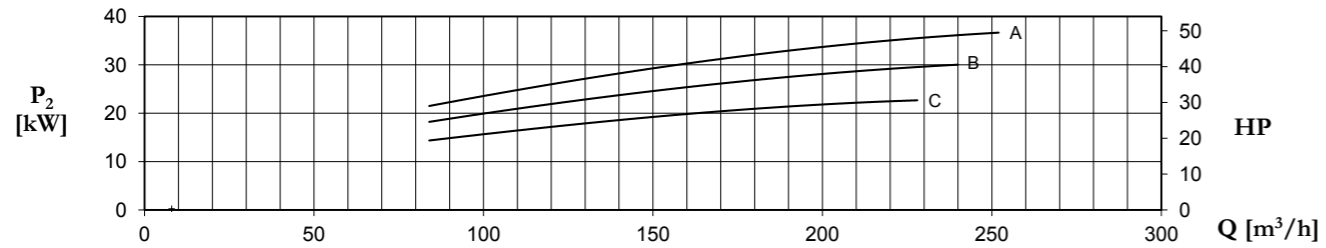
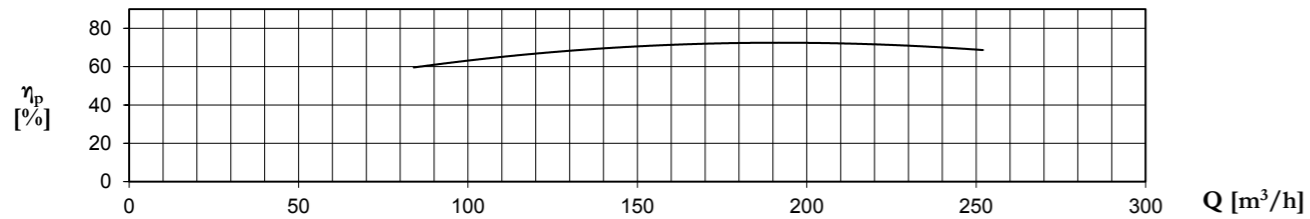
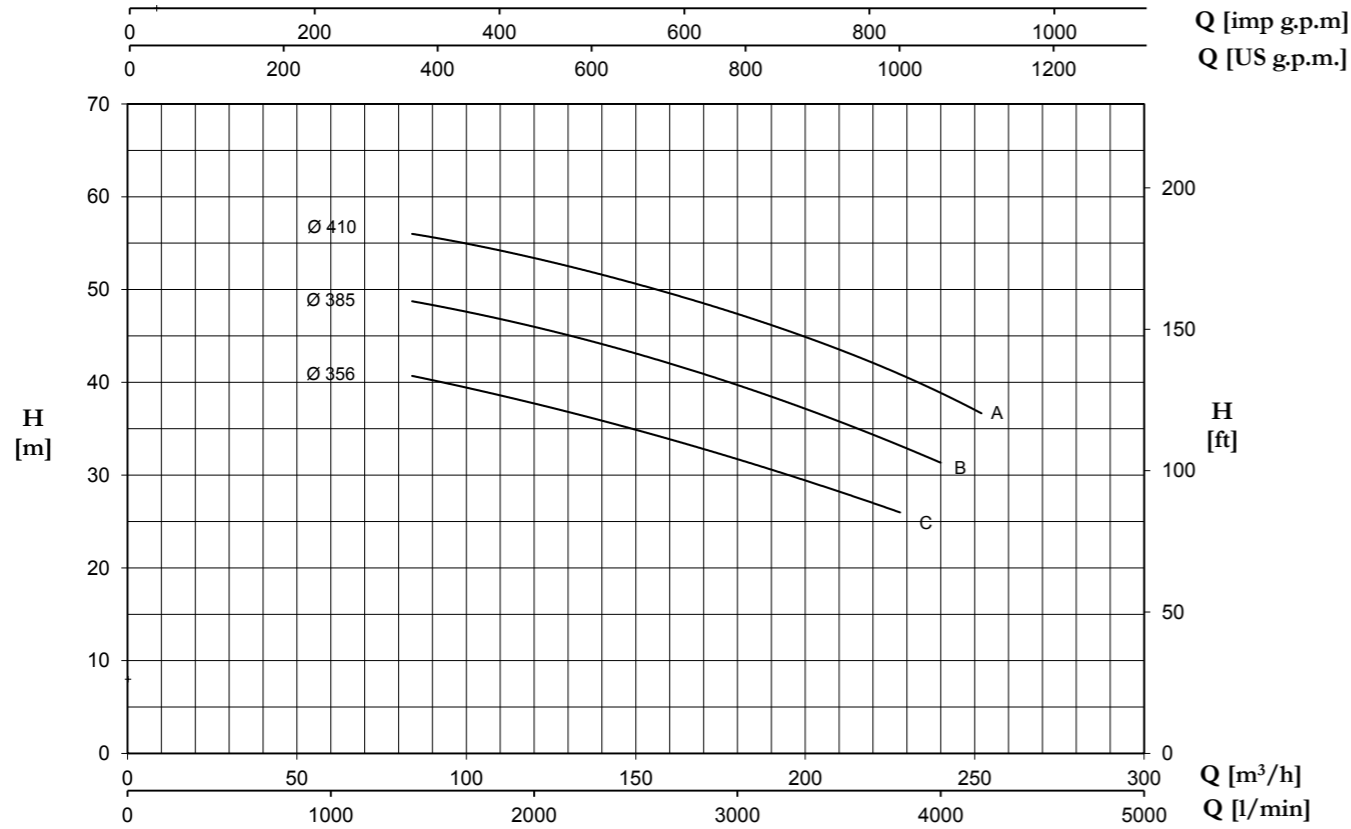

Tolerance: ISO 9906:2012 - Grade 3B

TYPE	Nominal Power (kW)	Motor Size	Q (m³/h - l/min)														
			0	84	108	132	156	180	204	216	228	240	252				
			0	1400	1800	2200	2600	3000	3400	3600	3800	4000	4200				
			H (m) / pump input power (kW)														
100-400C	22	180L	42,4	40,6	38,8	36,7	34,3	31,4	29,1	27,7	25,8						
			6,93	14,36	16,27	17,98	19,64	20,95	21,91	22,31	22,70						
100-400B	30	200L	50,3	48,7	47,0	44,9	42,6	39,8	36,5	34,7	33,1	31,6					
			9,32	18,20	20,75	23,04	25,03	26,80	28,36	29,01	29,56	30,00					
100-400A	37	225S	58,3	56,0	54,3	52,4	50,1	47,3	44,3	42,7	40,9	38,8	36,7				
			11,46	21,50	24,54	27,31	29,89	32,15	34,00	34,77	35,48	36,11	36,69				

~ 1450 r.p.m. 4MA/4MAT - 4MAX EN 733

125-250

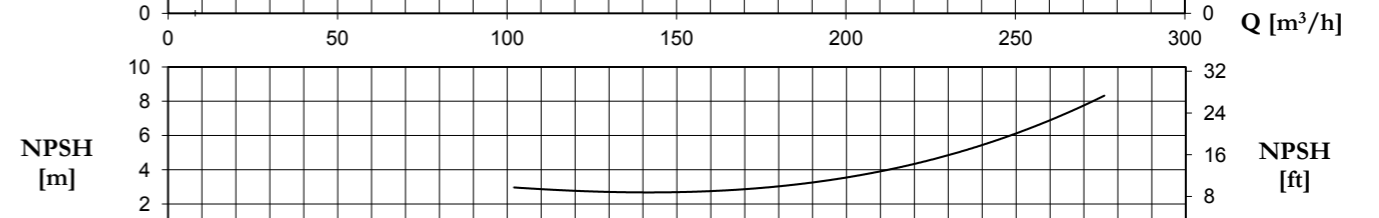
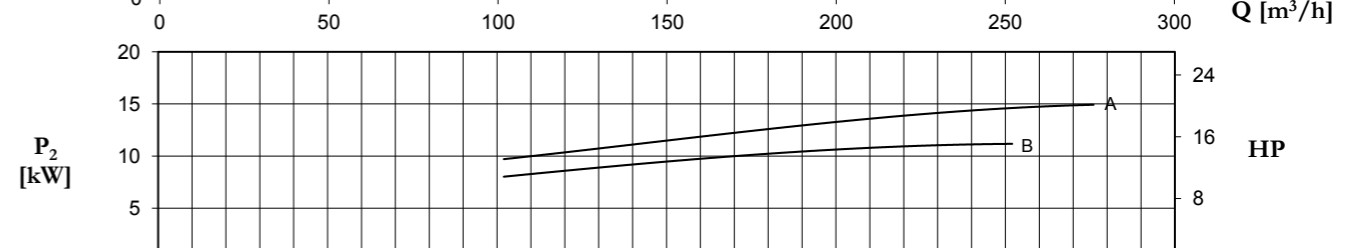
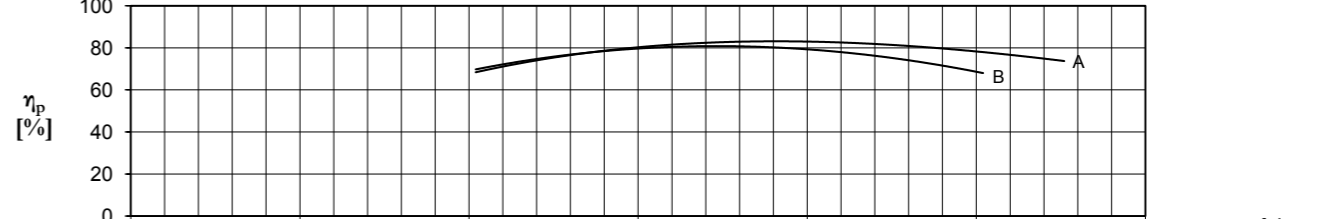
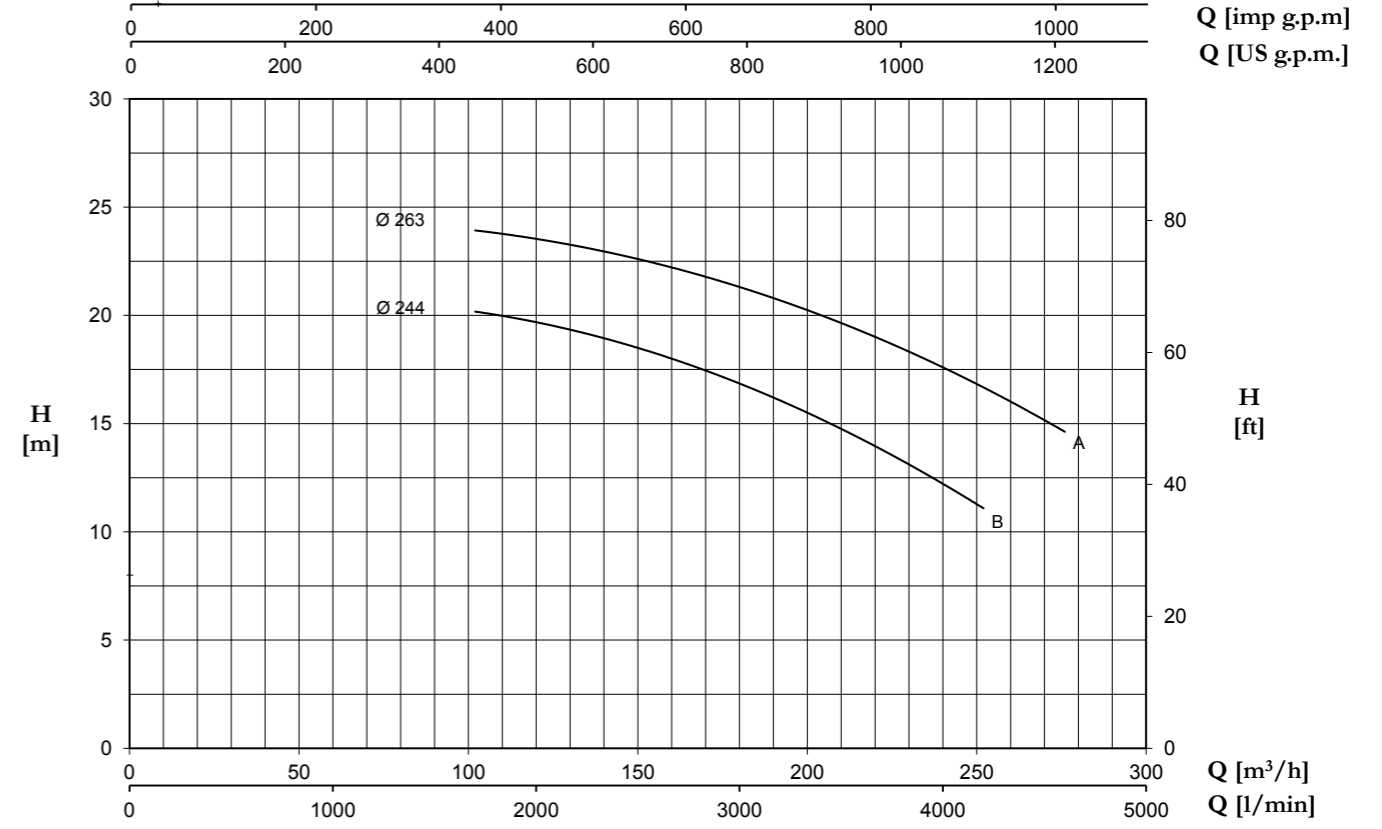

Tolerance: ISO 9906:2012 - Grade 3B

TYPE	Nominal Power (kW)	Motor Size	Q (m³/h - l/min)														
			0	102	114	126	138	150	168	192	216	252	276				
			0	1700	1900	2100	2300	2500	2800	3200	3600	4200	4600				
			H (m) / pump input power (kW)														
125-250B	11	160M	19,6	20,2	19,8	19,5	19,0	18,5	17,6	16,1	14,3	11,1					
			5,41	8,04	8,40	8,75	9,11	9,50	9,99	10,44	10,88	11,18					
125-250A	15	160L	23,2	24,0	23,6	23,3	23,0	22,6	21,9	20,7	19,3	16,6	14,7				
			6,18	9,71	10,14	10,57	11,02	11,47	12,16	13,02	13,77	14,57	14,94				

4MA/4MAT - 4MAX EN 733 ~ 1450 r.p.m.

125-315

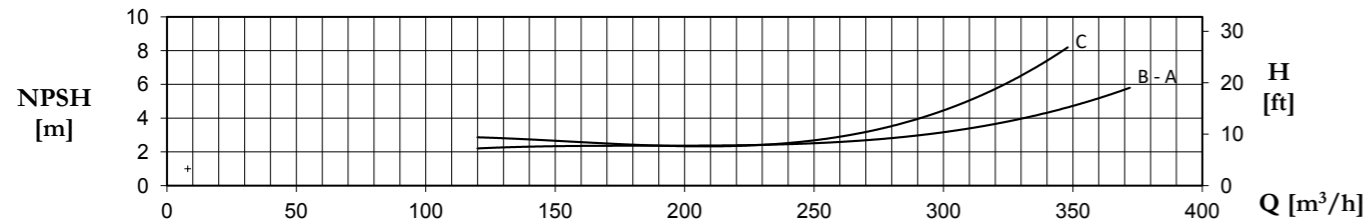
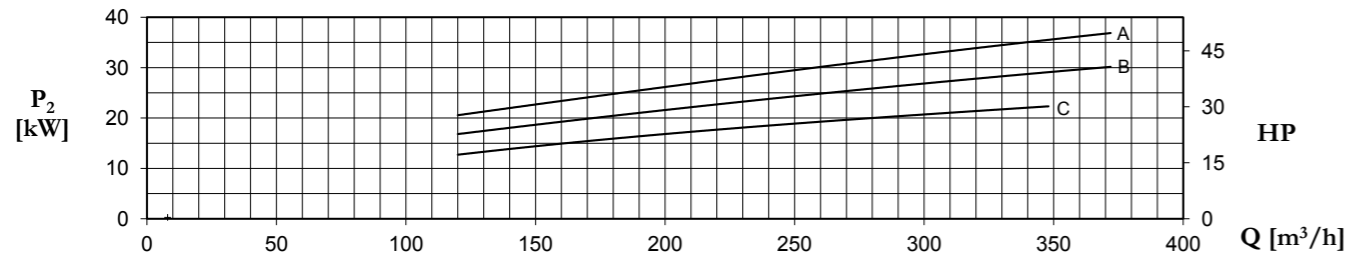
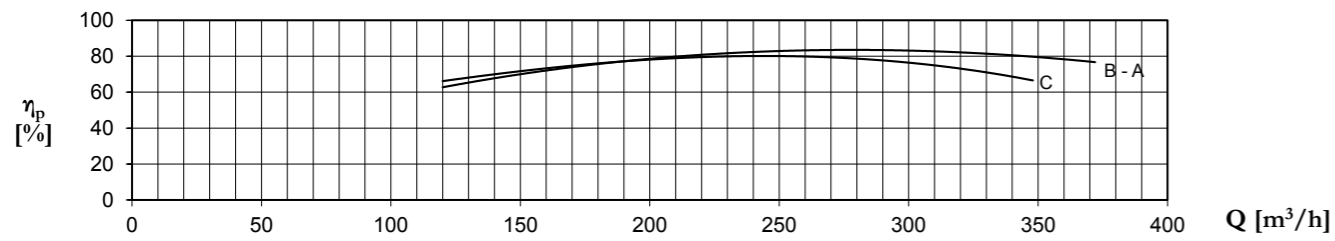
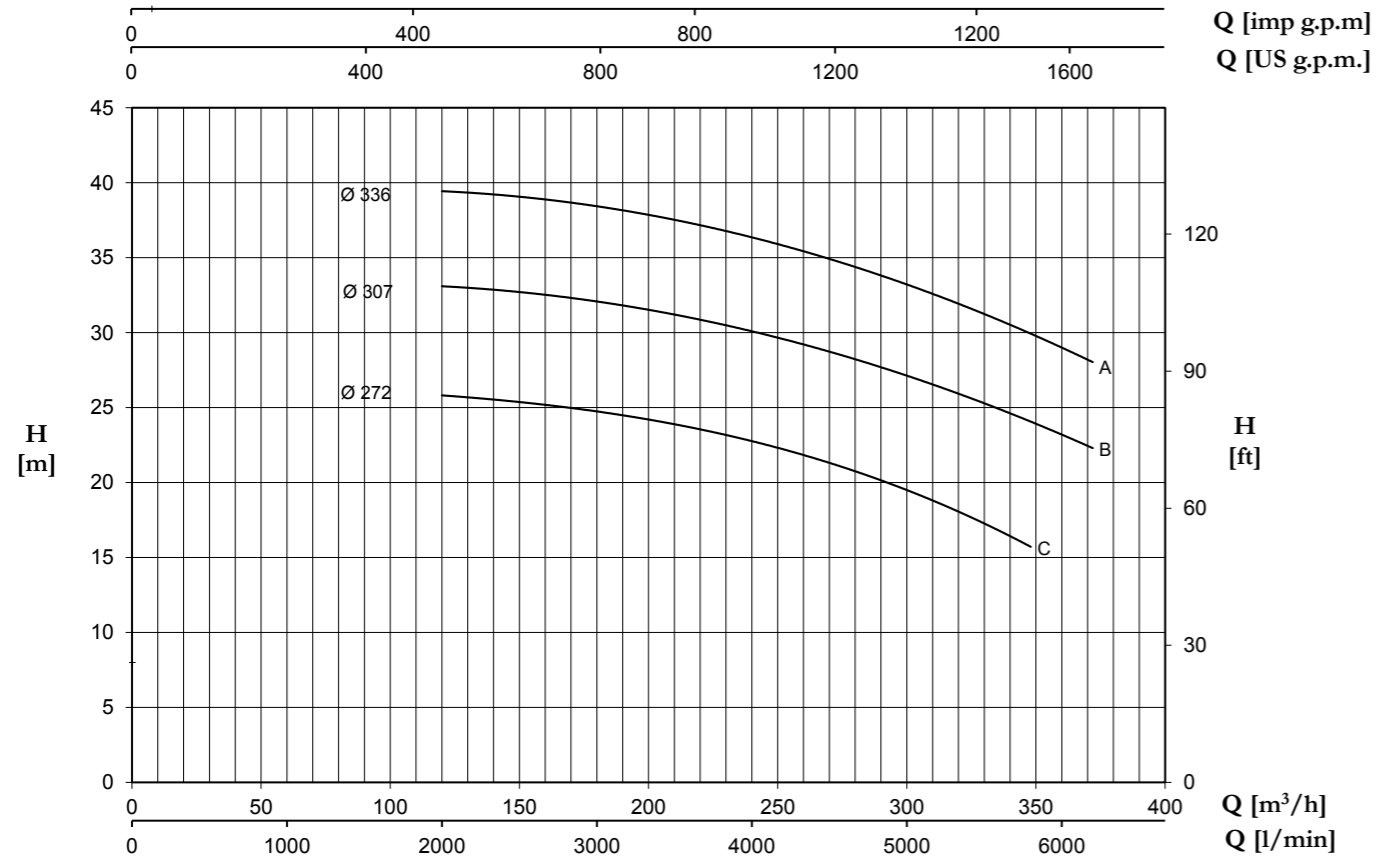

Tolerance: ISO 9906:2012 - Grade 3B

TYPE	Nominal Power (kW)	Motor Size	Q (m³/h - l/min)																			
			0					120														
			0	2000	2400	2600	3000	180	204	3400	3800	4200	228	252	348	372						
H (m)																						
pump input power (kW)																						
125-315C	22	180L	24,1	25,8	25,5	25,3	24,7	24,1	23,3	22,2	15,7		7,23	12,72	14,05	14,70	15,95	16,99	17,98	18,99	22,32	
125-315B	30	200L	31,5	33,0	32,9	32,7	32,1	31,3	30,6	29,6	24,2	22,2	9,52	16,73	18,36	19,15	20,43	21,67	23,13	24,48	29,14	30,13
125-315A	37	225S	38,6	39,6	39,2	38,8	38,1	37,6	37,0	36,2	29,6	28,2	11,88	20,51	22,29	23,17	24,84	26,36	27,97	29,66	35,58	36,82

~ 1450 r.p.m. 4MA/4MAT - 4MAX EN 733

125-400

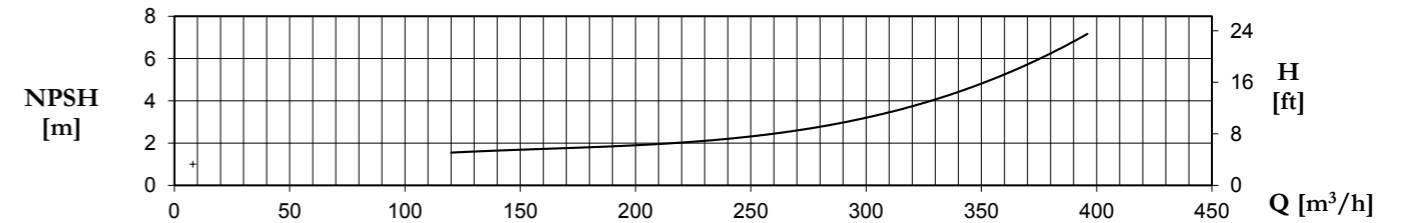
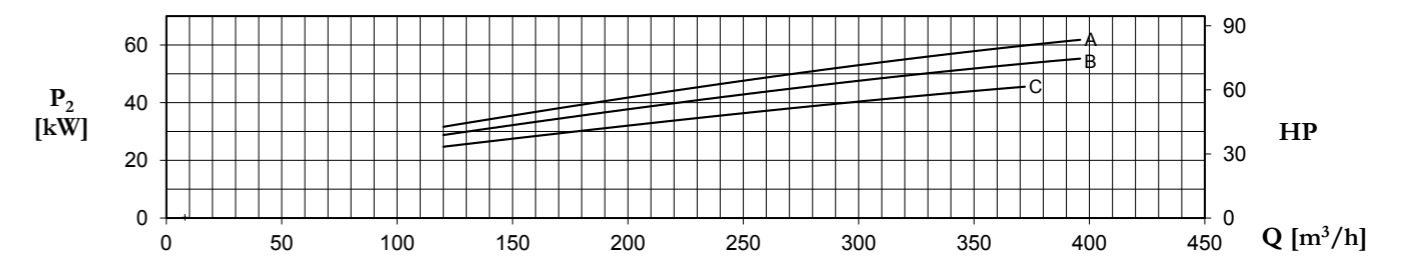
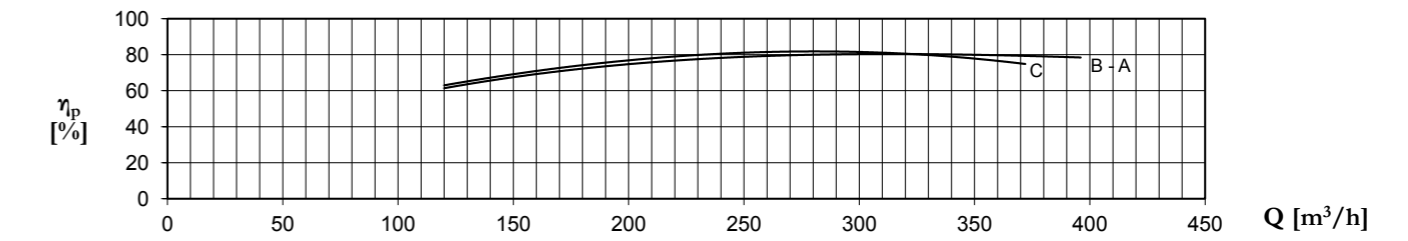
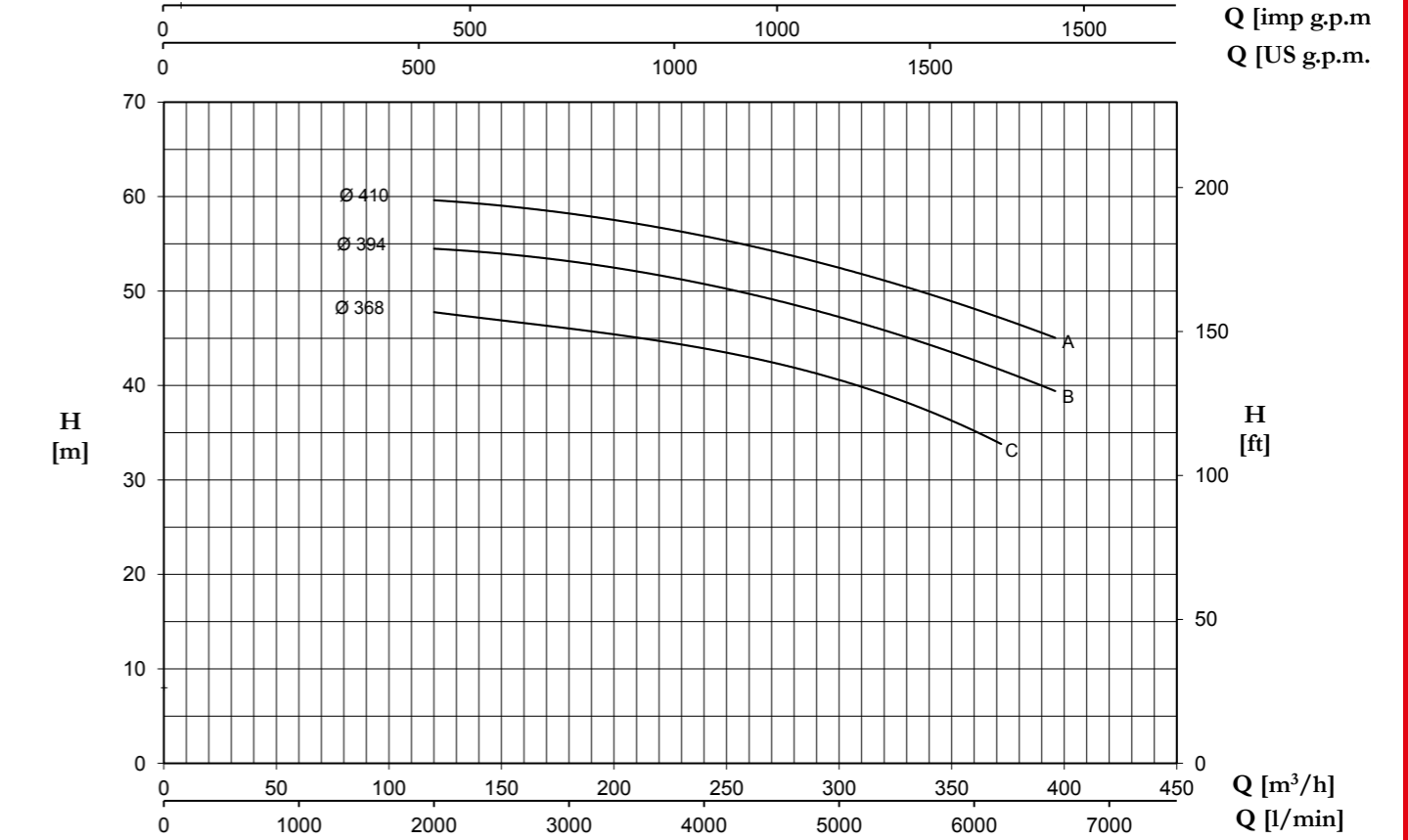

Tolerance: ISO 9906:2012 - Grade 3B

TYPE	Nominal Power (kW)	Motor Size	Q (m³/h - l/min)																			
			0					120														
			0	2000	2200	2500	2800	132	150	168	192	216	240	276	372	396						
H (m)																						
pump input power (kW)																						
125-400C	45	225M	46,2	47,6	47,5	47,0	46,5	45,7	44,7	43,7	42,4	33,8	13,91	24,65	25,83	27,62	29,31	31,22	33,24	35,62	38,53	45,52
125-400B	55	250M	53,4	54,5	54,3	54,0	53,5	52,7	51,7	50,6	48,8	42,0	16,79	28,74	30,15	32,25	34,30	36,85	39,30	41,82	45,43	53,55
125-400A	75	280S	58,6	59,5	59,4	59,1	58,7	57,8	56,8	55,7	53,9	47,2	18,95	31,66	33,20	35,52	37,81	40,77	43,66	46,50	50,49	59,76

4MA/4MAT - 4MAX EN 733 ~ 1450 r.p.m.

150-315

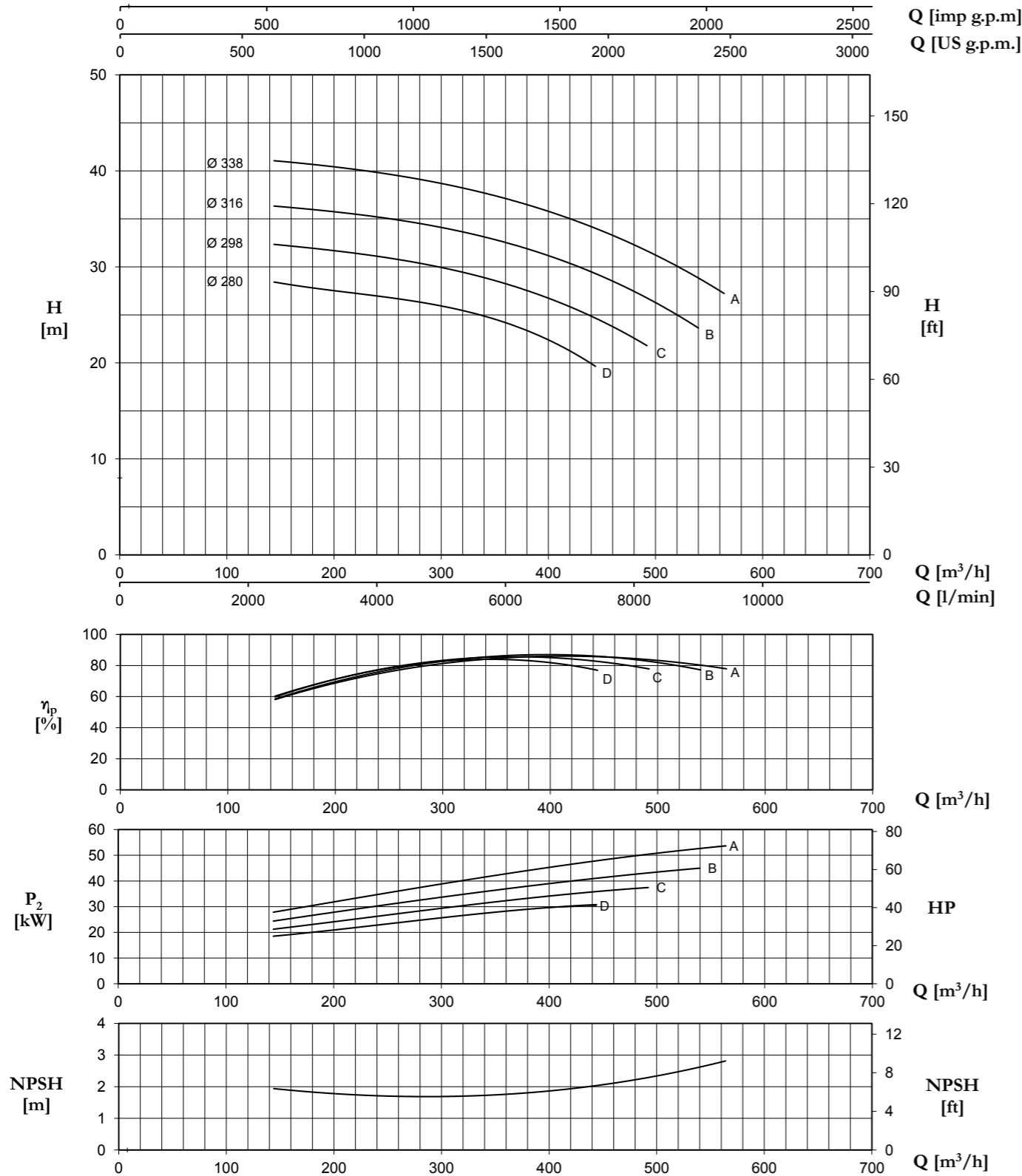

Tolerance: ISO 9906:2012 - Grade 3B

TYPE	Nominal Power (kW)	Motor Size	Q (m³/h - l/min)														
			pump input power (kW)														
			0	144	192	228	252	348	396	444	492	540	564				
150-315D	30	200L	25,7	28,3	27,9	27,2	26,5	24,7	22,7	19,6							
150-315C	37	225S	29,6	32,2	32,1	31,3	30,7	28,6	27,0	24,7	21,8						
150-315B	45	225M	34,0	36,3	36,0	35,4	34,9	32,8	31,3	29,3	26,9	23,6					
150-315A	55	250M	39,4	41,0	40,8	40,0	39,5	37,6	35,8	34,1	31,7	28,9	27,2				

~ 1450 r.p.m. 4MA/4MAT - 4MAX EN 733

150-400

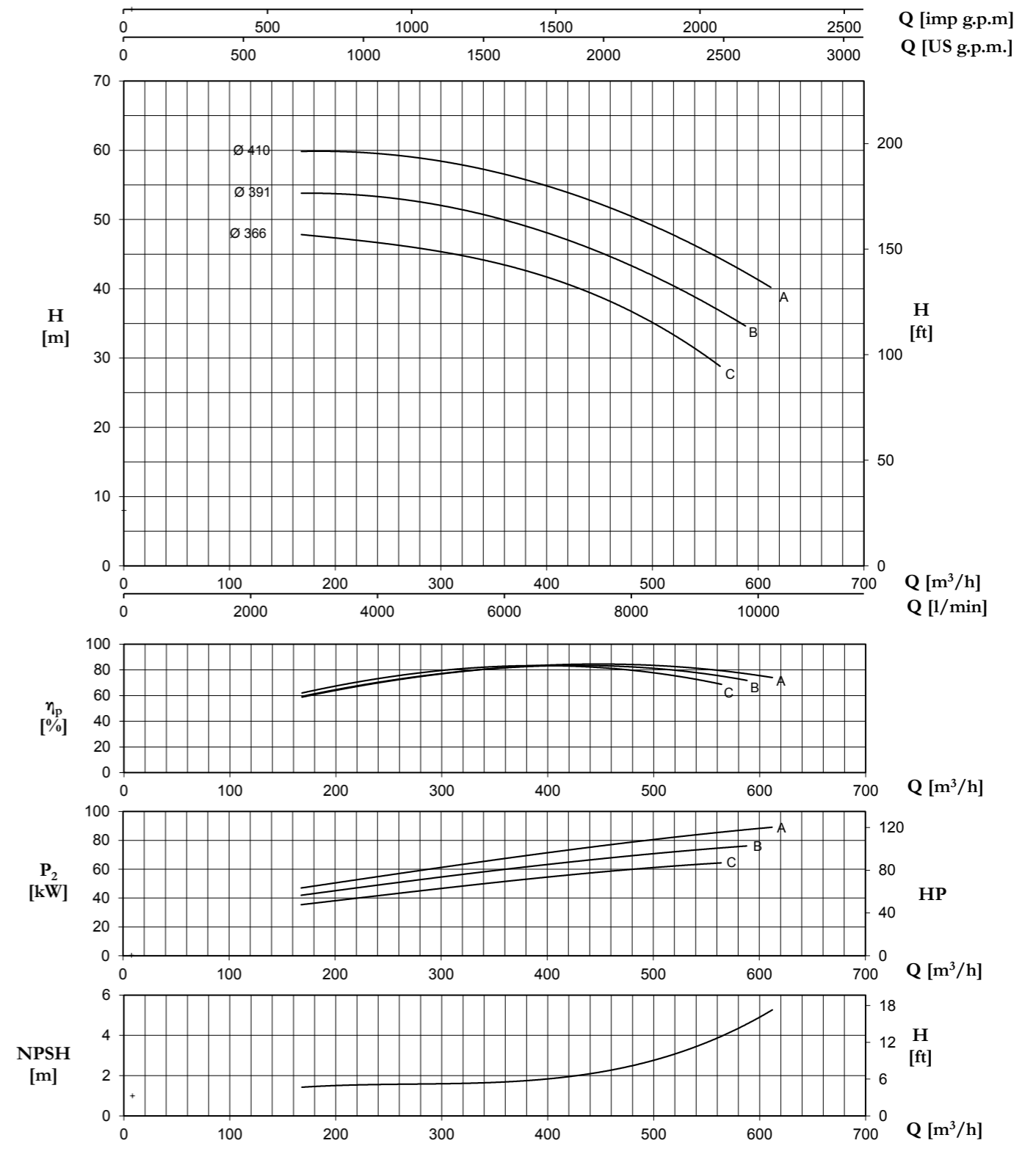

Tolerance: ISO 9906:2012 - Grade 3B

TYPE	Nominal Power (kW)	Motor Size	Q (m³/h - l/min)														
			pump input power (kW)														
			0	168	192	216	240	276	372	444	540	564	588	612			
150-400C	75	280S	45,6	47,8	47,6	47,2	46,7	41,65	45,8	43,1	39,2	31,5	28,7				
150-400B	75	280S	52,8	54,4	53,9	53,5	52,9	51,8	49,8	46,1	39,1	36,7	34,3				
150-400A	90	280M	59,0	60,3	60,0	59,9	59,1	58,1	56,0	53,3	46,7	44,5	42,2	39,8			

200-315

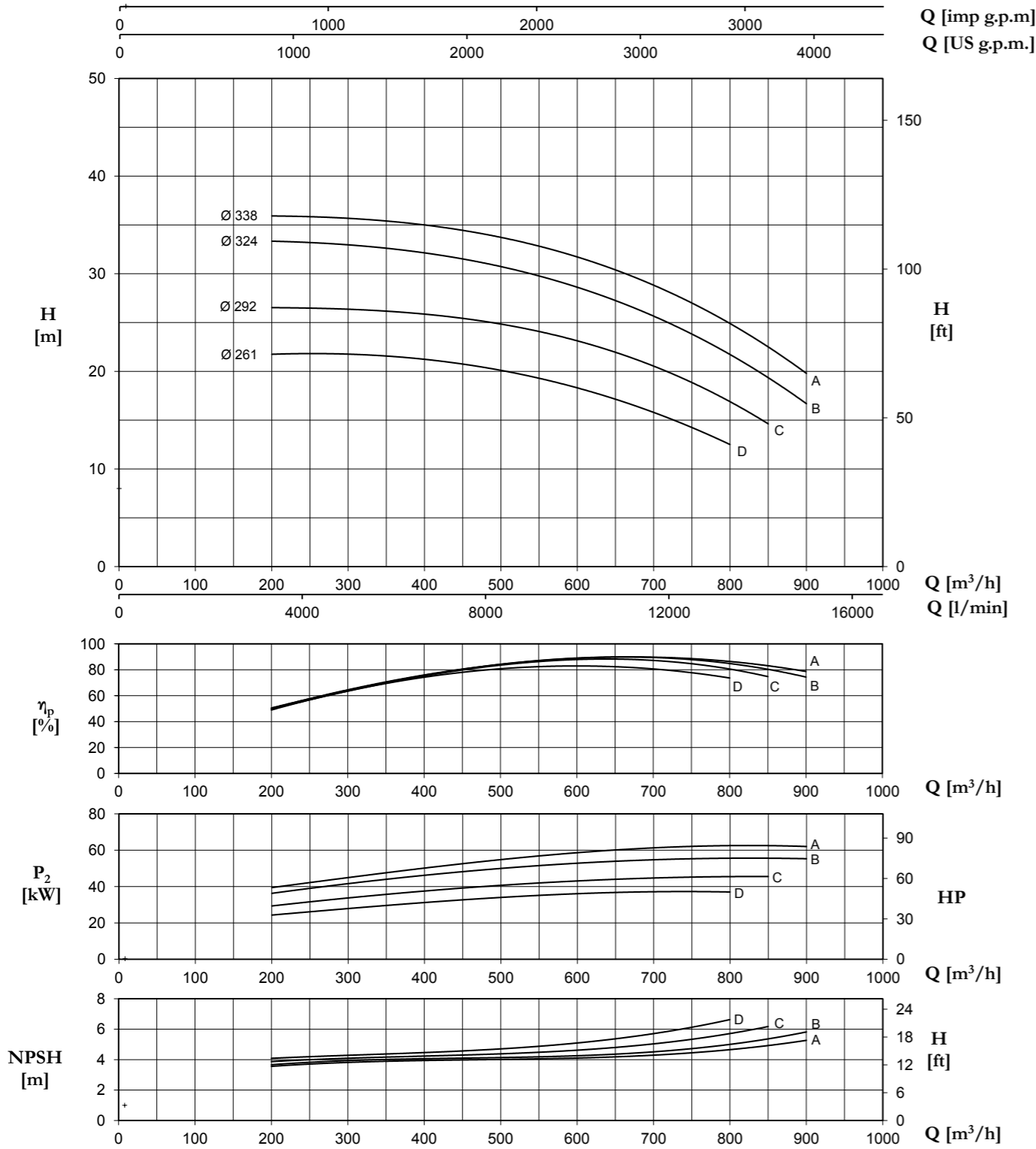

Tolerance: ISO 9906:2012 - Grade 3B

TYPE	Nominal Power (kW)	Motor Size	Q (m³/h - l/min)									
			0	200	250	400	600	800	850	900		
			0	3333	4167	5000	10000	13333	14167	15000		
H (m)												
pump input power (kW)												
200-315D	37	225S	21,2	21,7	21,8	21,2	18,3	12,5				
			18,00	24,31	26,11	31,21	36,07	37,00				
200-315C	45	225M	26,6	26,6	26,4	25,9	23,1	16,9	14,6			
			21,54	29,42	31,44	37,61	43,07	45,42	45,55			
200-315B	55	250M	33,4	33,4	33,2	32,2	28,6	21,7	19,4	16,7		
			25,04	36,30	38,91	46,32	52,72	55,67	55,62	55,25		
200-315A	75	280S	36,3	35,9	35,8	35,0	31,8	24,9	22,5	19,8		
			27,90	39,49	42,13	50,07	58,82	62,36	62,45	62,15		

200-400

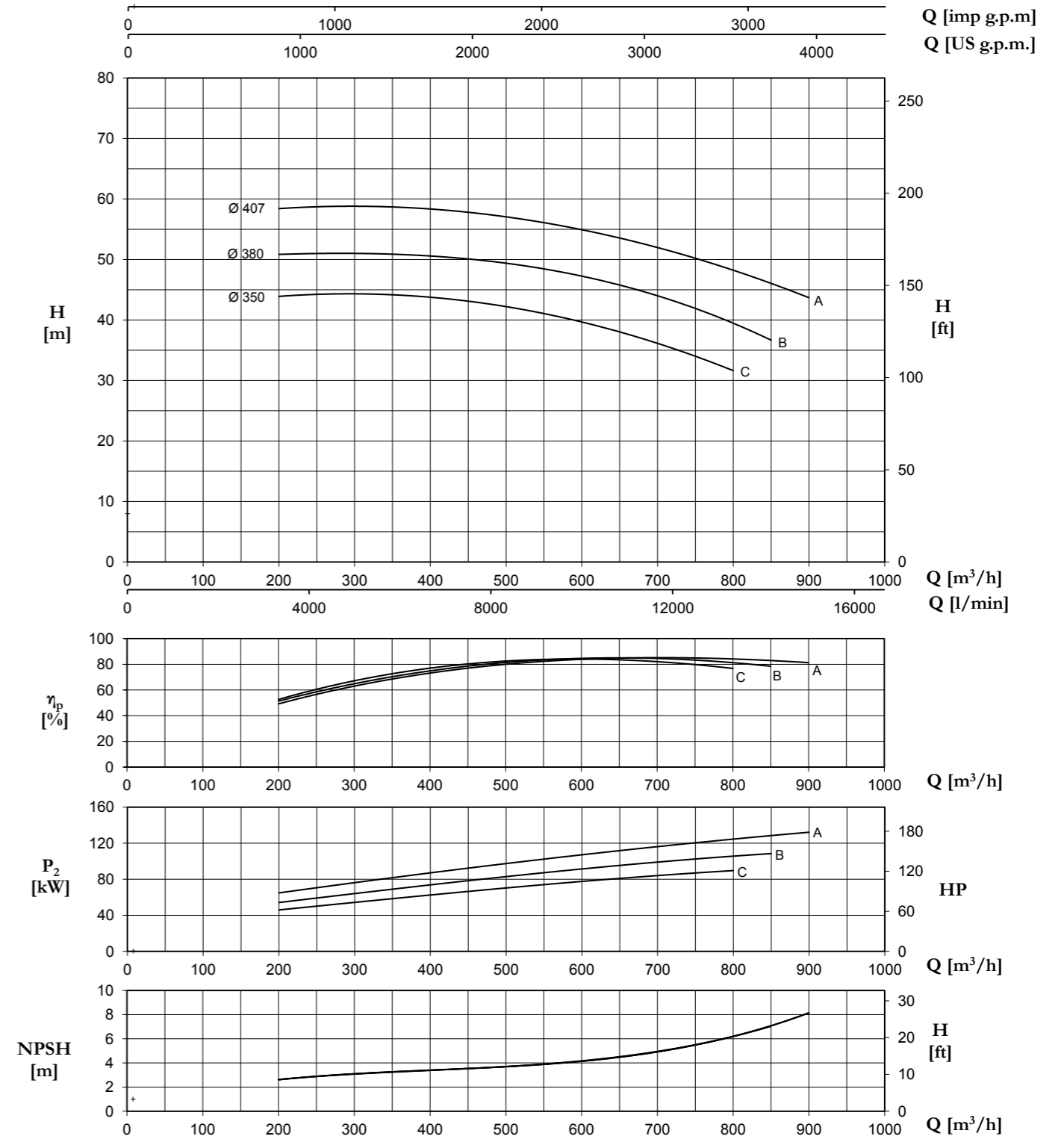

Tolerance: ISO 9906:2012 - Grade 3B

TYPE	Nominal Power (kW)	Motor Size	Q (m³/h - l/min)									
			0	200	250	400	600	800	850	900		
			0	3333	4167	6667	10000	13333	14167	15000		
H (m)												
pump input power (kW)												
200-400C	90	280M	43,0	44,1	44,1	43,6	39,9	31,5				
			31,27	45,90	50,14	62,49	77,58	89,60				
200-400B	110	315S	49,5	50,8	51,0	50,6	47,2	39,5	36,6			
			40,00	54,29	58,92	73,89	91,32	105,65	108,43			
200-400A	132	315M	57,2	58,5	58,6	58,2	55,2	48,2	45,6	44,0		
			49,00	65,01	70,26	87,26	107,05	124,54	128,46	132,15		

4MA/4MAT - 4MAX (No EN 733) ~ 1450 r.p.m.

250-315

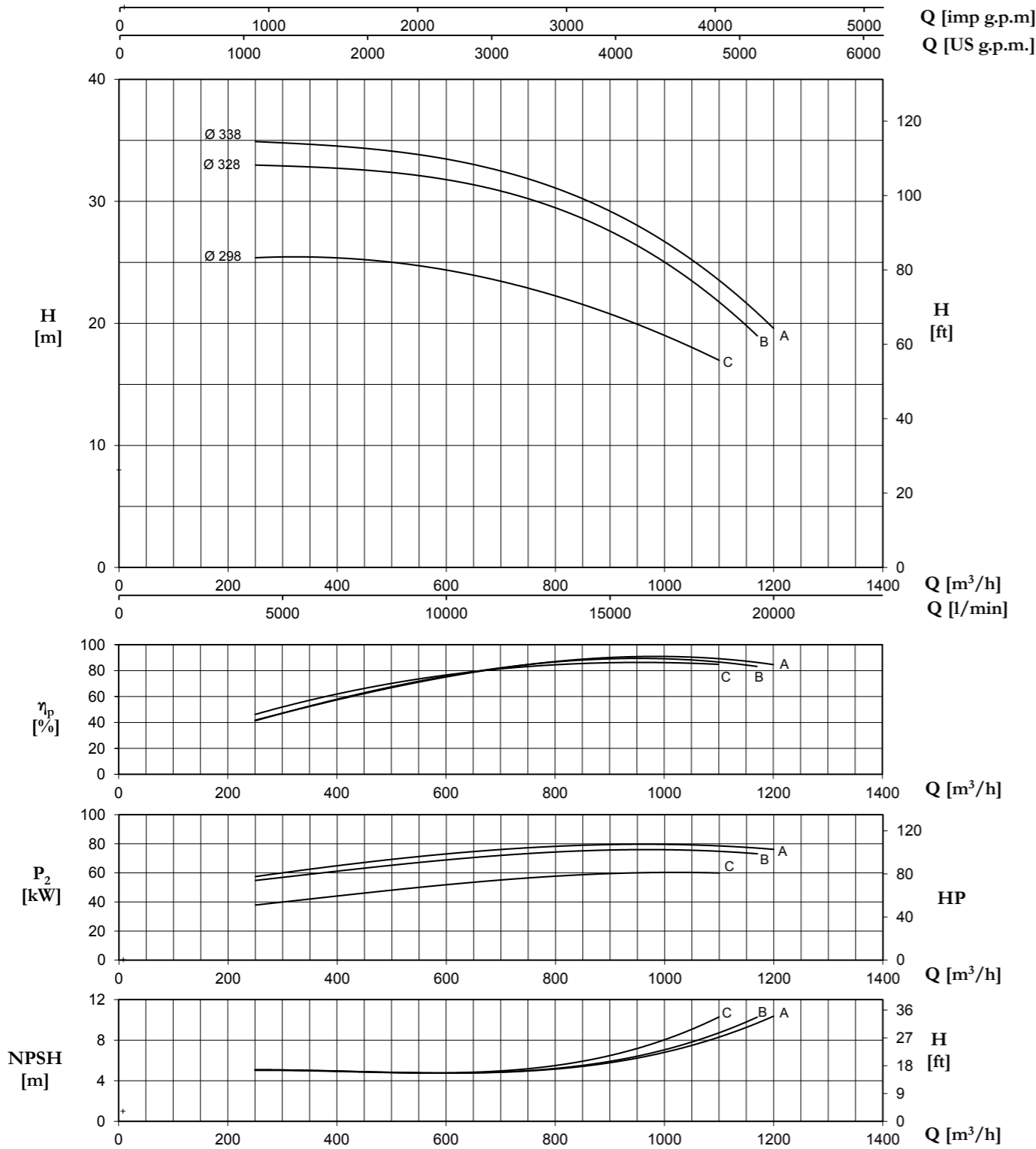

TYPE	Nominal Power (kW)	Motor Size	Q (m³/h - l/min)									
			0	250	400	600	800	850	900	1100	1170	1200
			0	4167	6667	10000	13333	14167	15000	18333	19500	20000
H (m) pump input power (kW)												
250-315C	55	280M	26,1	25,5	25,3	24,1	22,3	21,7	21,0	16,8		
	75	280S	28,00	37,82	44,23	51,71	57,65	58,82	59,57	59,89		
250-315B	75	280S	33,2	33,0	32,7	31,8	29,6	28,6	27,5	21,7	19,0	
			43,46	54,77	61,20	68,72	74,57	75,26	75,64	74,47	73,35	
250-315A	90	280M	35,8	35,0	34,4	33,3	31,3	30,4	29,3	23,0	20,7	20,0
			46,41	57,61	64,50	73,28	78,44	79,01	79,32	78,27	77,03	76,36

~ 1450 r.p.m. 4MA/4MAT - 4MAX (No EN 733)

250-400

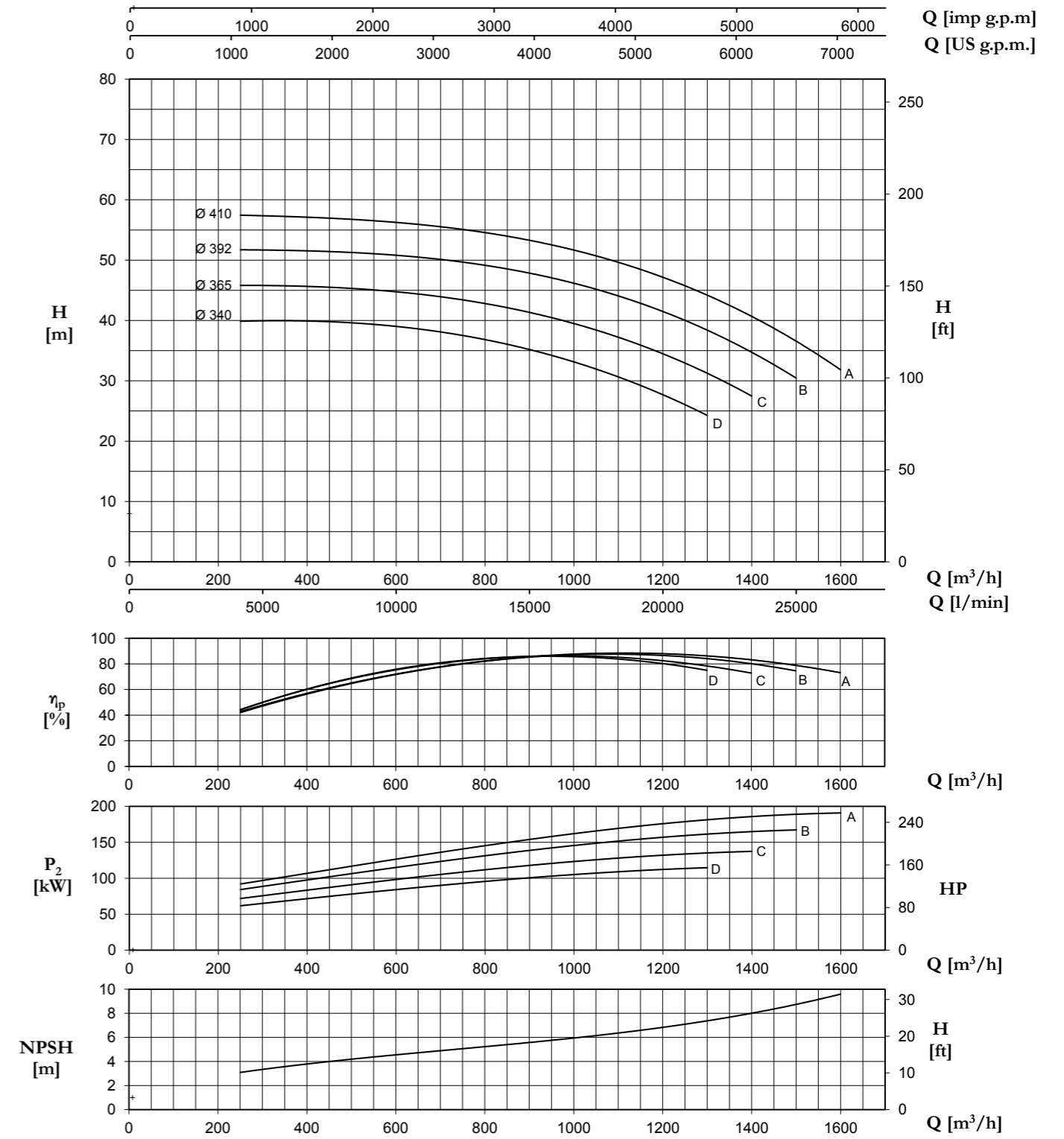

TYPE	Nominal Power (kW)	Motor Size	Q (m³/h - l/min)									
			0	250	600	900	1170	1200	1300	1400	1500	1600
			0	4167	10000	15000	19500	20000	21667	23333	25000	26667
H (m) pump input power (kW)												
250-400D	110	315S	38,3	39,9	39,0	35,2	28,6	27,7	24,3			
	132	315M	48,00	61,74	84,15	100,80	111,27	112,17	114,78			
250-400C	132	315M	44,0	45,8	44,9	41,2	35,4	34,5	31,3	27,4		
	160	315L	53,83	71,89	98,11	118,20	130,85	131,93	135,08	137,50		
250-400B	160	315L	50,0	51,7	51,0	47,6	42,3	41,5	38,5	34,8	30,3	
	200	315L	64,57	84,18	115,36	138,27	155,58	157,12	161,60	164,88	167,09	
250-400A	200	315L	55,7	57,4	56,5	53,0	47,9	47,1	44,3	40,8	36,6	31,7
			70,94	91,89	127,19	153,24	173,94	175,86	181,62	186,11	189,07	190,57

MA/MAT - MAX EN 733 ~ 2900 r.p.m.
4MA/4MAT - 4MAX EN 733 ~ 1450 r.p.m.

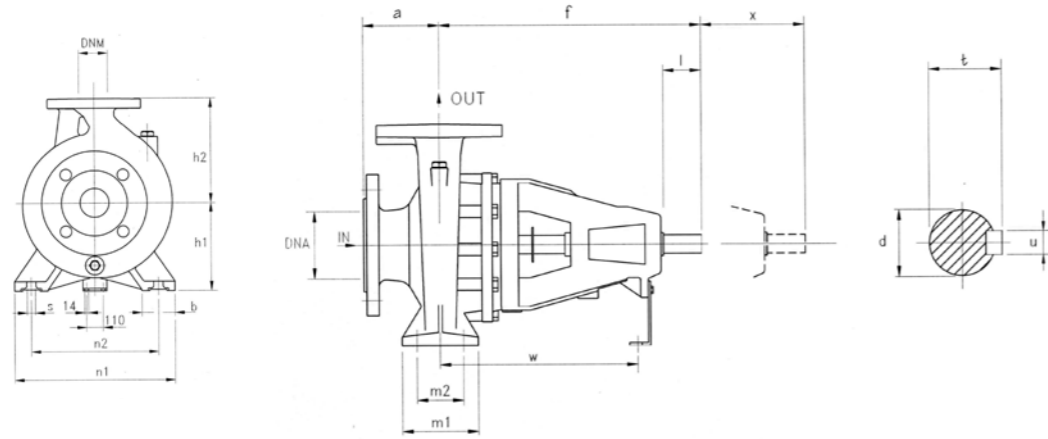

TYPE	DIMENSIONS (mm)																			I	L	M	Kg
	DNA	DNM	a	f	h1	h2	m1	m2	n1	n2	s	b	l	d	t	u	x	w					
32-160	50	32	80	360	132	160	100	70	240	190	14	50	50	24	27	8	100	260	535	320	445	38	
32-200			80	360	160	180	100	70	240	190	14	50	50	24	27	8	100	260	535	320	445	41	
32-250			100	360	180	225	125	95	320	250	14	65	65	24	27	8	100	260	680	405	545	49	
40-125	65	40	80	360	112	140	100	70	210	160	14	50	50	24	27	8	100	260	535	320	445	37	
40-160			80	360	132	160	100	70	240	190	14	50	50	24	27	8	100	260	535	320	445	40	
40-200			100	360	160	180	100	70	265	212	14	50	50	24	27	8	100	260	535	320	445	44	
40-250			100	360	180	225	125	95	320	250	14	65	50	24	27	8	100	260	680	405	545	49,5	
50-125	65	50	100	360	132	160	100	70	240	190	14	50	50	24	27	8	100	260	535	320	445	39,5	
50-160			100	360	160	180	100	70	265	212	14	50	50	24	27	8	100	260	535	320	445	44	
50-200			100	360	160	200	100	70	265	212	14	50	50	24	27	8	100	260	535	320	445	47	
50-250			100	360	180	225	125	95	320	250	14	65	50	24	27	8	100	260	680	405	545	53	
50-315			80	125	470	225	280	125	95	345	280	14	65	80	32	35,3	10	100	340	655	465	620	94,5
65-125	80	65	100	360	160	180	125	95	280	212	14	65	65	24	27	8	100	260	535	320	445	44,5	
65-160			100	360	160	200	125	95	280	212	14	65	65	24	27	8	100	260	535	320	445	49	
65-200			100	360	180	225	125	95	320	250	14	65	65	24	27	8	140	260	680	405	545	54	
65-250			100	470	200	250	160	120	360	280	19	80	80	32	35	10	140	340	680	405	545	76,5	
65-315			125	470	225	280	160	120	400	315	19	80	80	32	35	10	140	340	655	465	620	96	
80-160	100	80	125	360	180	225	125	95	320	250	14	65	50	24	27	8	140	260	680	405	545	58	
80-200			125	470	180	250	125	95	345	280	14	65	80	32	35	10	140	340	680	405	545	74	
80-250			125	470	200	280	160	120	400	315	18	80	80	32	35,3	10	140	340	655	465	585	91	
80-315			125	470	250	315	160	120	400	315	18	80	80	32	35,3	10	140	340	655	465	620	106	
100-200	125	100	125	470	200	280	160	120	360	286	18	80	80	32	35,3	10	140	340	655	465	620	95	
100-250			140	470	225	280	160	120	400	315	18	80	80	32	35,3	10	140	340	655	465	620	103	
100-315			140	470	250	315	160	120	400	315	18	80	80	32	35,3	10	140	340	655	465	620	122	
100-400			140	530	280	355	200	150	500	400	22	100	110	42	45,3	12	140	370	720	775	855	183,5	
125-250	150	125	160	530	315	450	200	150	400	315	22	100	110	32	45,3	12	140	370	655	465	620	132	
125-315			140	530	280	355	200	150	500	400	22	100	110	42	45,3	12	140	370	720	775	855	176	
125-400			140	530	315	400	200	150	500	400	22	100	110	42	45,3	12	140	370	720	775	855	198	
150-315	200	150	160	530	280	400	200	150	550	450	22	100	110	42	45,3	12	140	370	655	465	620	191	
150-400	200	150	160	530	315	450	200	150	550	450	22	100	110	42	45,3	12	140	370	720	775	855	218,5	
200-315	250	200	180	706	355	450	250	190	634	500	28	134	110	55	58,3	16	208	523	800	1200	1150	345	
200-400			180	706	355	500	250	190	634	500	28	134	110	55	58,3	16	214	523	800	1200	1150	346	
250-315	300	250	225	711	400	500	250	200	694	560	28	134	110	55	58,3	16	214	528	800	1200			
250-400			225	706	400	550	250	200	694	560	28	134	110	55	58,3	16	220	523	800	1200			

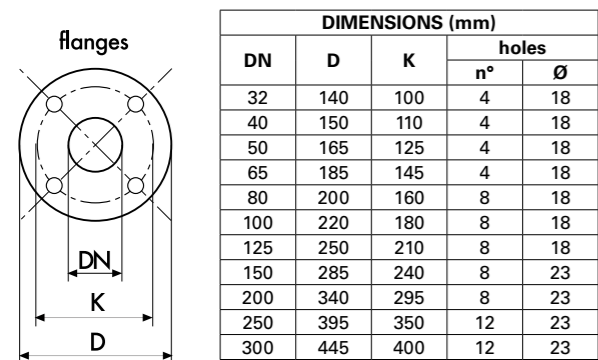

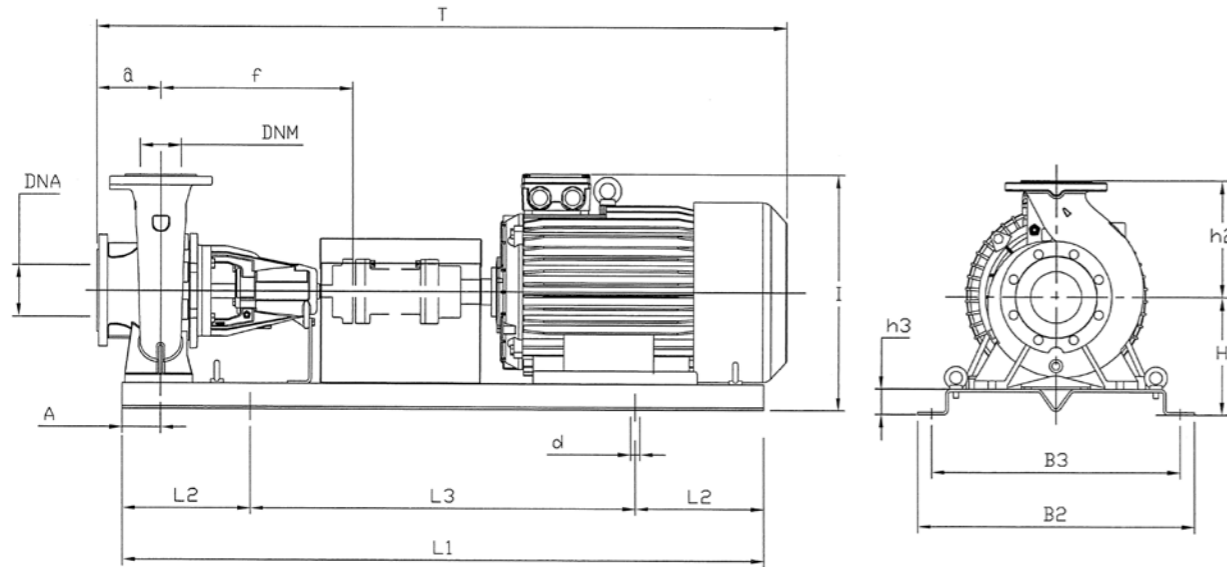

TYPE	kW	Motor Size	DIMENSIONS (mm)																Kg
			DNA	DNM	a	f	H	h2	h3	L1	L2	L3	B2	B3	A	d	T	I	
32-160C	0,37	71M	50	32	80	360	182	160	50	800	130	540	360	320	60	18	820	342	78
32-160B	0,37	71M	50	32	80	360	182	160	50	800	130	540	360	320	60	18	820	342	78
32-160A	0,55	80M	50	32	80	360	182	160	50	800	130	540	360	320	60	18	820	342	78,1
32-200C	0,75	80M	50	32	80	360	210	180	50	800	130	540	360	320	60	18	820	390	82,1
32-200B	1,1	90S	50	32	80	360	210	180	50	800	130	540	360	320	60	18	855	390	86,1
32-200A	1,1	90S	50	32	80	360	210	180	50	800	130	540	360	320	60	18	855	390	86,1
32-250C	1,5	90S	50	32	100	360	230	225	50	1000	170	660	450	400	75	22	1025	455	105,7
32-250B	1,5	90S	50	32	100	360	230	225	50	1000	170	660	450	400	75	22	1025	455	105,7
32-250A	2,2	100L	50	32	100	360	230	225	50	1000	170	660	450	400	75	22	1025	455	111,7
40-125C	0,37	71M	65	40	80	360	162	140	50	800	130	540	360	320	60	18	820	302	78,5
40-125B	0,37	71M	65	40	80	360	162	140	50	800	130	540	360	320	60	18	820	302	78,5
40-125A	0,55	80M	65	40	80	360	162	140	50	800	130	540	360	320	60	18	820	307	78,2
40-160B	0,55	80M	65	40	80	360	182	160	50	800	130	540	360	320	60	18	820	342	81,2
40-160A	0,75	80M	65	40	80	360	182	160	50	800	130	540	360	320	60	18	820	342	81,2
40-200B	1,1	90S	65	40	100	360	210	180	50	900	150	600	390	350	60	18	940	390	91,8
40-200A	1,1	90S	65	40	100	360	210	180	50	900	150	600	390	350	60	18	940	390	91,8
40-200A	1,5	90S	65	40	100	360	210	180	50	900	150	600	390	350	60	18	940	390	97,8
40-250C	1,1	90S	65	40	100	360	230	225	50	1000	170	660	450	400	75	22	1025	455	101,3
40-250C	1,5	90S	65	40	100	360	230	225	50	1000	170	660	450	400	75	22	1025	455	107,3
40-250B	2,2	100L	65	40	100	360	230	225	50	1000	170	660	450	400	75	22	1025	455	113,3
40-250A	2,2	100L	65	40	100	360	230	225	50	1000	170	660	450	400	75	22	1025	455	113,3
40-250A	3	100L	65	40	100	360	230	225	50	1000	170	660	450	400	75	22	1025	455	117,3

TYPE	kW	Motor Size	DIMENSIONS (mm)																Kg
			DNA	DNM	a	f	H	h2	h3	L1	L2	L3	B2	B3	A	d	T	I	
50-125B	0,55	80M	65	50	100	360	182	160	50	800	130	540	360	320	60	18	840	342	81,1
50-125A	0,75	80M	65	50	100	360	182	160	50	800	130	540	360	320	60	18	840	342	81,1
50-160B	0,75	80M	65	50	100	360	210	180	50	800	130	540	360	320	60	18	840	390	85,6
50-160A	1,1	90S	65	50	100	360	210	180	50	800	130	540	360	320	60	18	875	390	89,6
50-200C	1,1	90S	65	50	100	360	210	200	50	900	150	600	390	350	60	18	940	410	95,2
50-200B	1,5	90S	65	50	100	360	210	200	50	900	150	600	390	350	60	18	940	410	101,2
50-200A	1,5	90S	65	50	100	360	210	200	50	900	150	600	390	350	60	18	940	410	101,2
50-250C	2,2	100L	65	50	100	360	230	225	50	1000	170	660	450	400	75	22	1025	455	117,2
50-250C	3	100L	65	50	100	360	230	225	50	1000	170	660	450	400	75	22	1025	455	121,2
50-250B	3	100L	65	50	100	360	230	225	50	1000	170	660	450	400	75	22	1025	455	121,2
50-250A	4	112M	65	50	100	360	230	225	50	1000	170	660	450	400	75	22	1025	455	150
50-315C	5,5	132S	80	50	125	470	275	280	50	1120	190	740	490	440	75	22	1170	555	192,1
50-315B	7,5	132M	80	50	125	470	275	280	50	1120	190	740	490	440	75	22	1200	555	204,1
50-315A	11	160M	80	50	125	470	275	280	50	1250	205	840	540	490	75	22	1303	555	250,1
65-125B	0,75	80M	80	65	100	360	210	180	50	800	130	540	360	320	60	18	840	390	87,4
65-125A	1,1	90S	80	65	100	360	210	180	50	800	130	540	360	320	60	18	875	390	91,4
65-160C	1,5	90S	80	65	100	360	210	200	50	900	150	600	390	350	60	18	940	410	104,5
65-160B	1,5	90S	80	65	100	360	210	200	50	900	150	600	390	350	60	18	940	410	104,5
65-160A	2,2	100L	80	65	100	360	210	200	50	900	150	600	390	350	60	18	940	410	110,5
65-200C	2,2	100L	80	65	100	360	230	225	50	1120	190	740	490	440	75	22	1145	455	123,8
65-200B	3	100L	80	65	100	360	230	225	50	1120	190	740	490	440	75	22	1145	455	127,8
65-200A	3	100L	80	65	100	360	230	225	50	1120	190	740	490	440	75	22	1145	455	127,8
65-250B	4	112M	80	65	100	470	250	250	50	1120	190	740	490	440	90	22	1130	500	158
65-250B	5,5	132S	80	65	100	470	250	250	50	1120	190	740	490	440	90	22	1175	500	175
65-250A	5,5	132S	80	65	100	470	250	250	50	1120	190	740	490	440	90	22	1175	500	175
65-315CM	7,5	132M	80	65	125	470	275	280	50	1250	205	840	540	490	90	22	1285	555	211,5
65-315BM	11	160M	80	65	125	470	275	280	50	1250	205	840	540	490	90	22	1343	555	252,5
65-315AM	11	160M	80	65	125	470	275	280	50	1250	205	840	540	490	90	22	1343	555	252,5
80-160E	1,1	90S	100	80	125	360	230	225	50	1000	170	660	450	400	75	22	1050	455	113,1
80-160D	1,5	90S	100	80	125	360	230	225	50	1000	170	660	450	400	75	22	1050	455	119,1
80-160C	1,5	90S	100	80	125	360	230	225	50	1000	170	660	450	400	75	22	1050	455	119,1
80-160B	2,2	100L	100	80	125	360	230	225	50	1000	170	660	450	400	75	22	1050	455	125,1
80-160A	3	100L	100	80	125	360	230	225	50	1000	170	660	450	400	75	22	1050	455	129,1
80-200B	4	112M	100	80	125	470	230	250	50	1120	190	740	490	440	75	22	1170	480	156,8
80-200B	5,5	132S	100	80	125	470	230	250	50	1120	190	740	490	440	75	22	1200	480	173,8
80-200A	5,5	132S	100	80	125	470	230	250	50	1120	190	740	490	440	75	22	1200	480	173,8
80-250B	5,5	132S	100	80	125	470	250	280	50	1250	205	840	540	490	90	22	1285	530	195,8
80-250A	7,5	132M	100	80	125	470	250	280	50	1250	205	840	540	490	90	22	1285	530	202
80-315B	11	160M	100	80	125	470	300	315	50	1250	205	840	540	490	90	22	1343	615	263,8
80-315A	15	160L	100	80	125	470	300	315	50	1400	230	940	610	550	90	26	1435	615	290,8
100-200B	5,5	132S	125	100	125	470	250	280	50	1120	190	740	490	440	90	22	1200	530	197,8
100-200A	7,5	132M	125	100	125	470	250	280	50	1120	190	740	490	440	90	22	1240	530	209,8
100-250E	7,5	132M	125	100	140	470	275	280	50	1250	205	840	540	490	90	22	1300	555	222,8
100-250D	7,5	132M	125	100	140	470	275	280	50	1250	205	840	540	490	90	22	1300	555	222,8
100-250D	11	160M	125	100	140	470	275	280	50	1250	205	840	540	490	90	22	1358	555	263,8
100-250A	11	160M	125	100	140	470	275	280	50	1250	205	840	540	490	90	22	1358	555	263,8
100-315B	15	160L	125	100	140	470	300	315	50	1400	230	940	610	550	90	26	1450	615	312,7
100-315A	18,5	180M	125	100	140	470	300	31											